



**ARMAX**

# SS988HP

SAFARI ARMAX SNORKEL  
FORD P703 RANGER RAPTOR  
3.0L V6 Twin Turbo EcoBoost Engine

**N.B: Not compatible with North American vehicles**  
**N.B: Not compatible with some manufacturers side rails**



Update 03/06/2026

## Parts List

ITEM	PART NO.	DESCRIPTION	QTY
1	684-133-600	BODY - SNORKEL (SS988HP)	1
2	000-135-980	ARMAX AIR RAM ASSEMBLY	1
3	684-032-600	BRACKET - UPPER MOUNTING	1
4	000-002-100	BOLT - HEX - 6mm x 1.0 x 14mm (SEMS)	2
5	000-958-625	POP RIVET - 4.8mm x 10mm (Black Anodised)	3
6	684-435-600	GASKET - UPPER MOUNTING BRACKET (Nylon)	1
7	000-110	STUD - 8mm x 1.25 x 25mm - S/S	6
8	000-311-300	WASHER - BODY - 8mm x 30mm - S/S	6
9	000-205-300	NUT - NYLOC - 8mm x 1.25mm - S/S	6
10	684-024-600	HOSE - AIR ENTRY	1
11	684-025-600	PLATE - HOSE SUPPORT - S/S (Side/Front Upper)	1
12	684-025-625	PLATE - HOSE SUPPORT - S/S (Front Upper)	1
13	684-025-650	PLATE - HOSE SUPPORT - S/S (Side LH)	1

14	684-025-675	PLATE - HOSE SUPPORT - S/S (Lower Large)	1
15	684-025-700	PLATE - HOSE SUPPORT - S/S (Lower Small #1)	1
16	684-025-725	PLATE - HOSE SUPPORT - S/S (Lower Small #2)	1
17	684-025-750	PLATE - HOSE SUPPORT - S/S (Lower Side)	1
18	684-025-775	PLATE - HOSE SUPPORT - S/S (Upper Side)	1
19	000-958-175	POP RIVET - 4.0mm x 17mm	22
20	000-300-350	WASHER - BODY - 4.0mm x 12mm - S/S	2
21	000-1914	CLAMP - HOSE - 130/150mm - S/S	1
22	000-951-480	SCREW - S/T - 4.2mm x 13mm - (Black)	4
23	000-987-365	CABLE TIE - 7.8mm x 365mm	1
24	000-987-178	CABLE TIE - 4.8mm x 178mm	4
25	684-217-600	TEMPLATE - AIR CLEANER - Front	1
26	684-217-625	TEMPLATE - AIR CLEANER - Lower Front	1
27	684-217-650	TEMPLATE - AIR CLEANER - Side	1
28	684-217-675	TEMPLATE - AIR CLEANER – Bottom Rear	1
29	684-217-700	TEMPLATE - AIR CLEANER – Side Intermediate	1
30	684-017-600	TEMPLATE - FENDER	1



# SS988HP

SAFARI ARMAX SNORKEL  
FORD P703 RANGER RAPTOR  
3.0L V6 Twin Turbo EcoBoost Engine

**N.B: Not compatible with some manufacturers side rails**

## Installation Guide

### Fitment to:

- Right Hand Side

### Fitting Time:

- 270min

### Special Tools:

- Body Saw (Reciprocating)
- Pop Rivet gun (Swivel Head)
- Step Drill and Metric Drill Bits
- Sikaflex 227 Adhesive Sealant
- Allen Key Set (Metric)
- Cutting Pliers
- Die Grinder
- Files
- Masking Tape
- Loctite 243 (thread lock)
- Touch-up paint

**Prior to commencing the installation, it is the installer's responsibility to verify that all components and particularly the fender template (Item 30) are correct.**

### Attention Installer:

***Prior to commencing the installation of the SS988HP Safari ARMAX Snorkel, please discuss the following with the customer.***

***N.B: Due to the high performance characteristics of the SS988HP Safari ARMAX Snorkel, increased induction levels may be heard.***

1

Remove the following in accordance with the factory service manual:

- Air Cleaner Assembly
- RH Mud Flap
- RH Inner Guard Liner (Main Splash Guard Section)
- RH Front Fender Flare (Wheel Arch Moulding)
- RH Inner Guard Liner (Secondary Splash Guard Section)

***Hint: Cover the air intake duct with a plastic bag or rag to prevent any foreign matter from entering the engines air intake and potentially causing turbocharger / engine damage.***

***Caution: Extreme care must be taken when removing the Front Wheel Arch Moulding, the wheel arch moulding clip mounts are very easily broken off.***

***Hint: To release the plastic clips use a 7mm / 8mm 1/4" drive socket and extension bar.***

2

Remove and discard the perforated section from the fender template (Item 30) as shown.

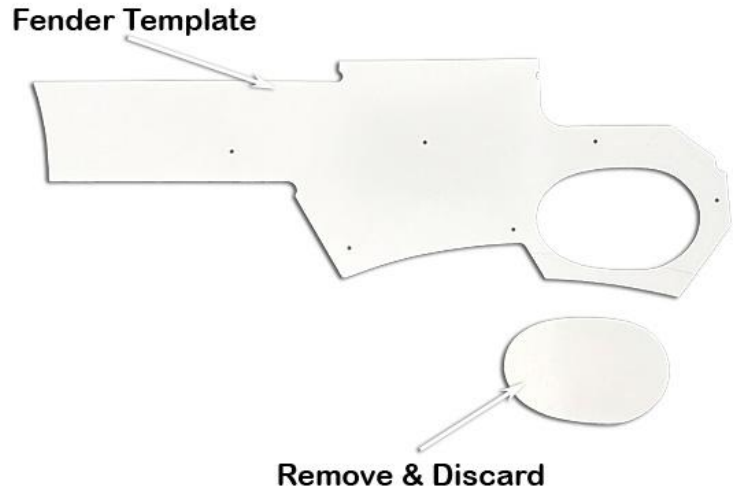

3

Re-Install the RH Fender Flare onto the Fender panel as shown.



4

Align the fender template (Item 30) with the upper and rear edges of the right hand fender as shown.

Tape the template to the fender with masking tape, the template **MUST** follow the profile of the fender panel whilst being taped.

Mark all hole positions and the cut-out section with a felt tip pen onto the RH Fender and RH Fender Flare.

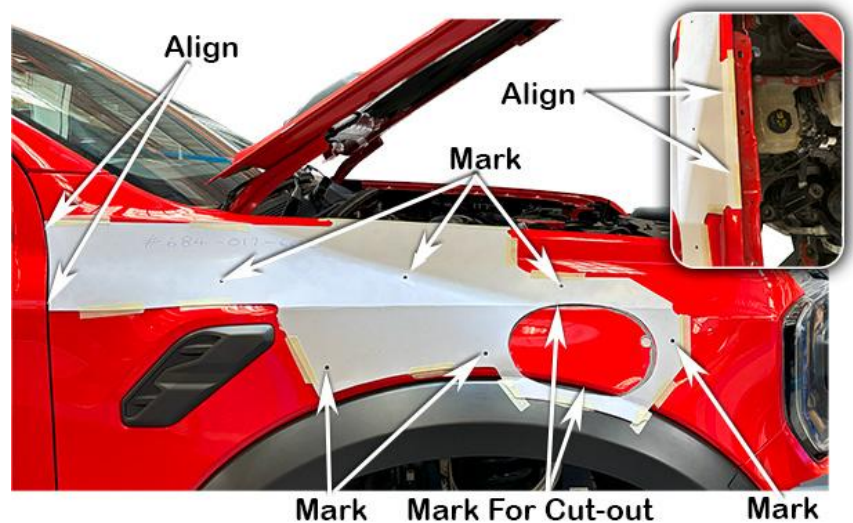

Fold up the lower section of the Fender Template (Item 30) that is overlapping the fender flare.

**N.B: Do Not Remove Template from RH Fender.**

Remove the RH Fender Flare from the RH Fender Panel.

Re-Position & tape the lower section of the Fender Template (Item 30) to the Fender Panel and Mark the remaining cut-out section onto the RH Fender Panel, as shown.

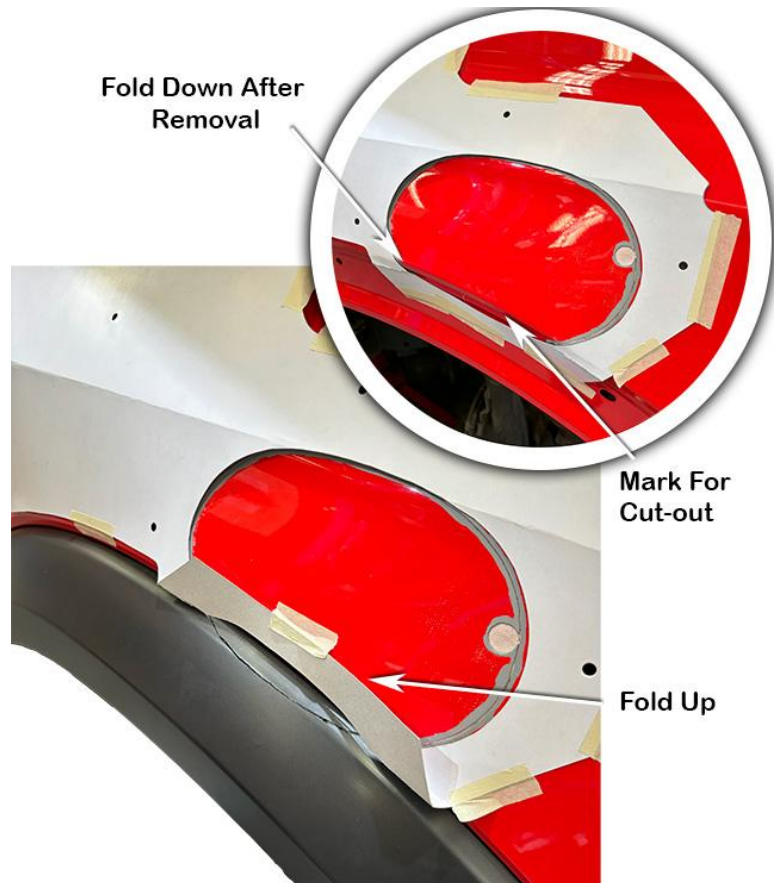

**6** Drill a pilot hole for each of the marked hole positions.

Use a step drill to drill the six mounting holes to 16mm diameter.

Drill 1 or 2, 10mm diameter holes in the cut-out section for a start/stop point for the body saw. Using the body saw, cut the main hole in the fender as marked from the template cut-out in step 3, cutting on the outside of the marked cut line.

Thoroughly deburr and paint all holes and cut section of fender to prevent rust.

**Caution:** The drill bit length is extremely critical when drilling the pilot holes and 16mm diameter holes in the fender. The washer bottle assembly is mounted directly behind the area of the holes. **Do Not** use long drill bits.

**Hint:** Tape over the Fender vent and any other parts where metal swarf / filings can be trapped.

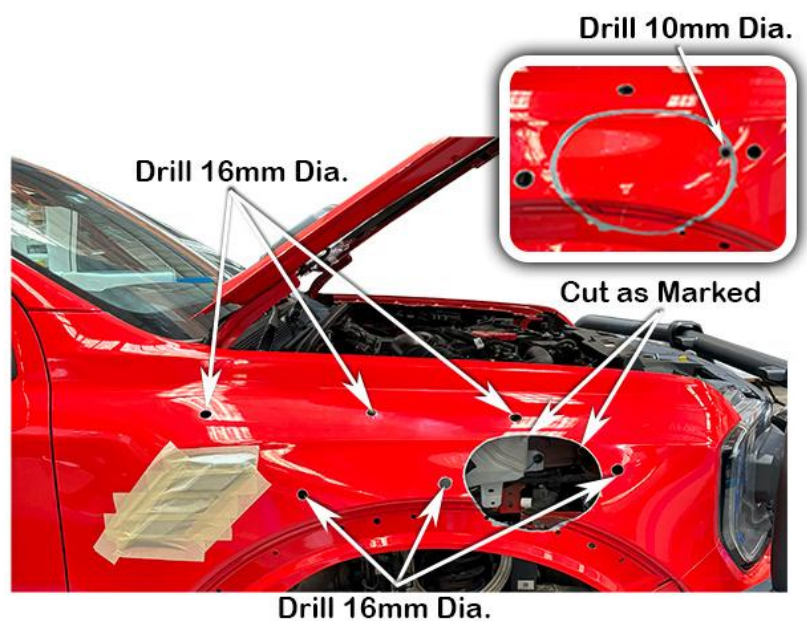

Using a Body Saw cut the RH Fender Flare (Wheel Arch Moulding) along the marked cut line.

Clean up & Deburr edge to ensure no loose plastic remains along the cut edge.



#### **NEW ZEALAND INSTALLATIONS ONLY :**

Safari have developed 2 methods of Snorkel A pillar attachment, for the conventional method please proceed with the current document alternatively please see the link below for further instructions.

[www.safari4x4.co.nz/apillarmounting](http://www.safari4x4.co.nz/apillarmounting)

Install the upper mounting bracket (Item 3) to the snorkel body (Item 1) with hex bolts (Item 4).

Apply Loctite 243 to each of the stainless steel mounting studs (Item 7) and install the studs finger tight into the snorkel body (Item 1) mounting inserts, as shown.

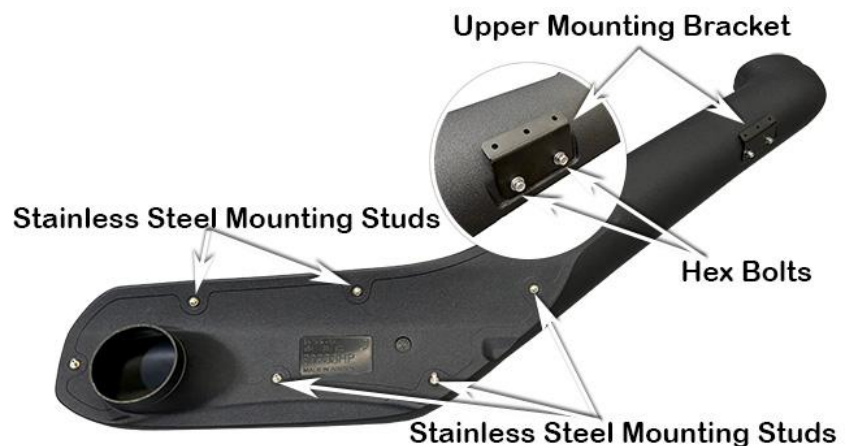

Locate the four dimples around the inlet of the Snorkel body.

Drill a 2.0mm pilot hole at each of the four dimple locations as shown.

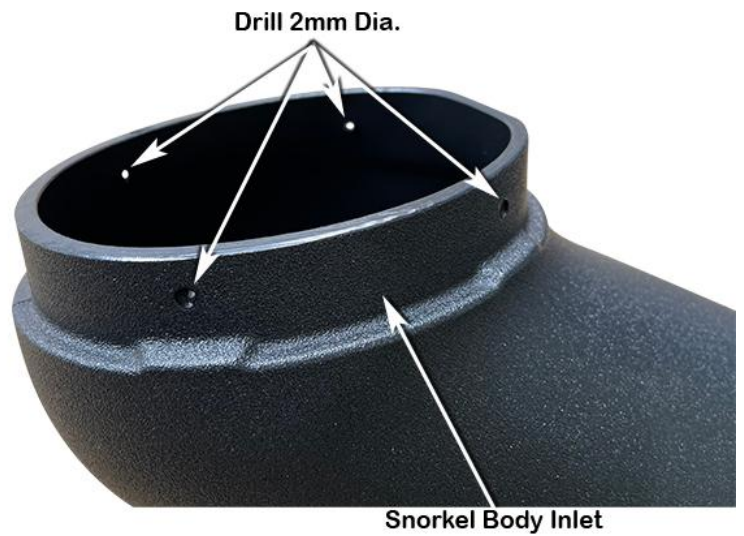

Place a strip of masking tape along the A-pillar panel.

Carefully install the snorkel body (Item 1) to the fender.

With the snorkel body correctly positioned, mark the outline of the upper mounting bracket (Item 3) onto the masking tape.

The distance from the marked line to front door edge should be approximately 10.0 - 12.0mm as shown.

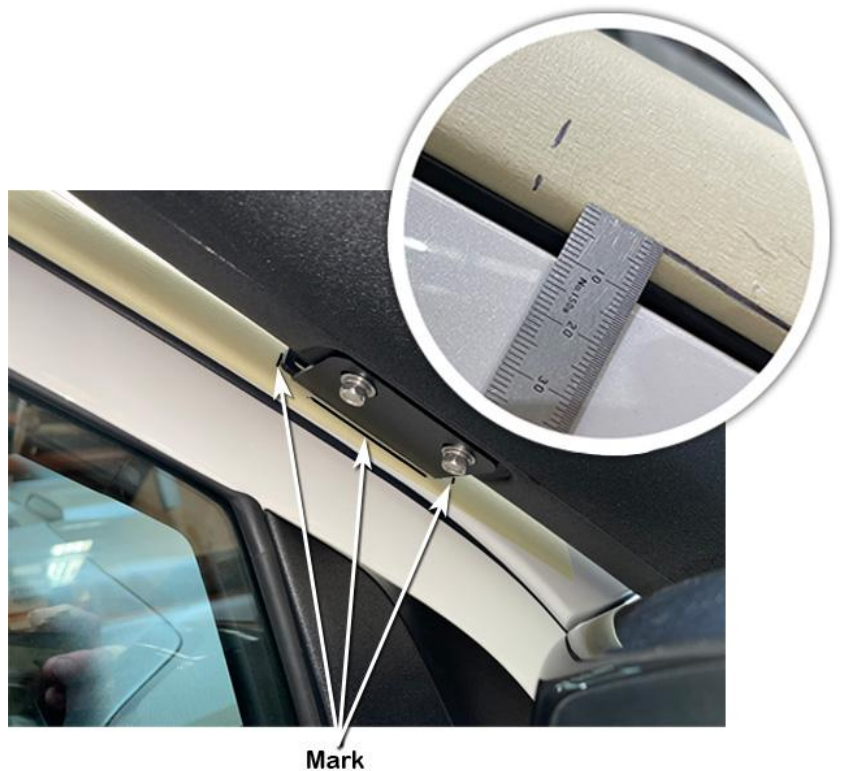

Remove the snorkel body (Item 1) from the vehicle and remove the upper mounting bracket (Item 3) from the snorkel body.

Position the upper mounting bracket (Item 3) onto the A-pillar and align the bracket with the marked bracket outline.

Mark the three mounting slot positions with a felt tip pen.

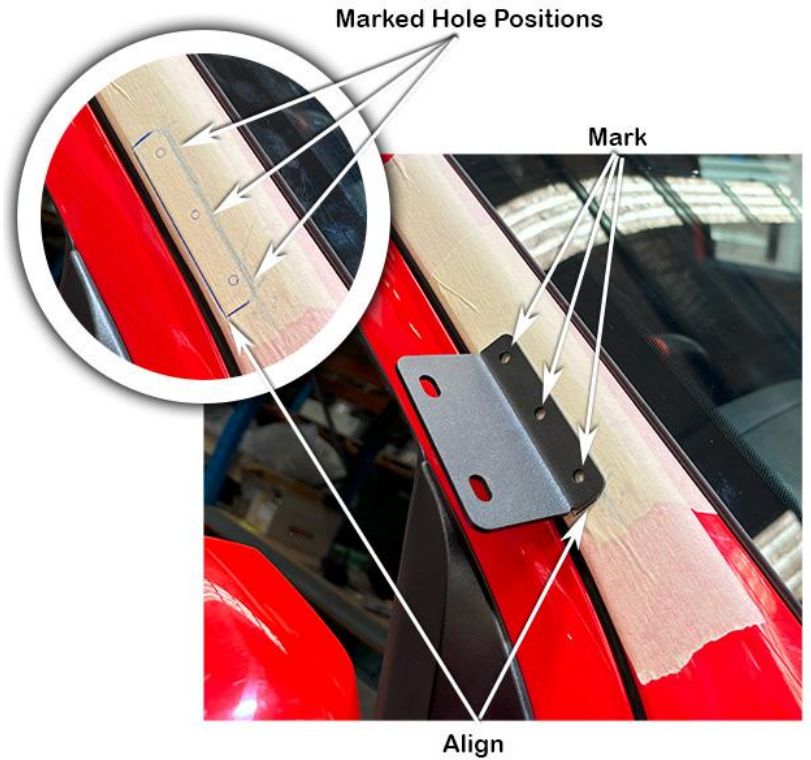

Drill a pilot hole at each of the three marked hole positions.

Drill each hole position to 5.0mm diameter with a 5.0mm drill bit.

Remove the masking tape.

Deburr and paint holes to prevent rust.

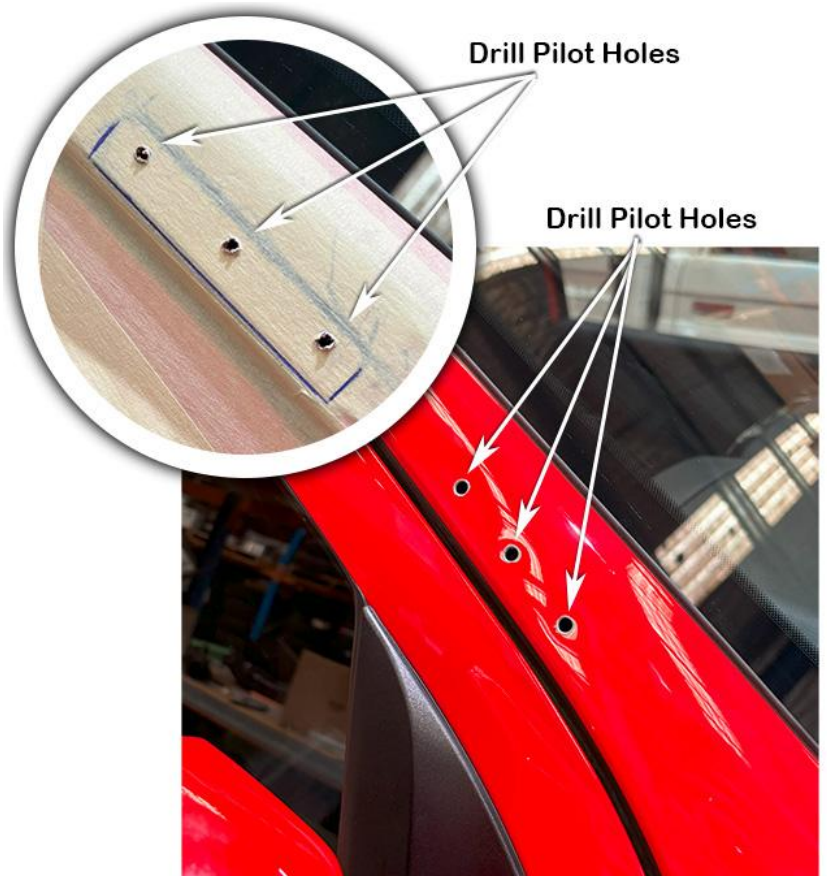

Install the nylon bracket gasket (Item 6) to the upper mounting bracket (Item 3) and install the upper mounting bracket and nylon bracket gasket onto the A-pillar.

Install the three pop rivets (Item 5) through the bracket and gasket and into the three 5.0mm diameter holes in the A-pillar panel.

**Hint: Apply two small drops of superglue to the upper mounting bracket and stick the nyloc bracket gasket to the upper mounting bracket.**



Using a pop rivet gun, secure the three pop rivets attaching the upper mounting bracket and nylon bracket gasket to the A-pillar panel.

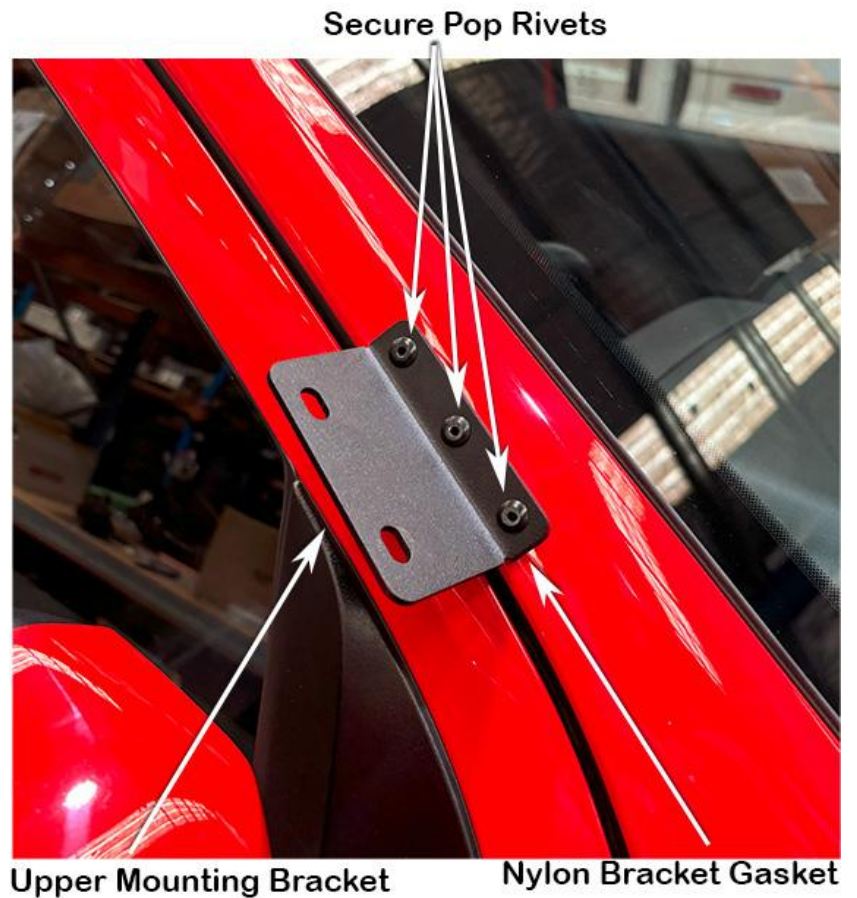

Unclip the washer motor loom and washer hose from the washer bottle bracket.

The unused front washer bottle bracket (shown) must be removed. Mark a cut line and using the body saw, cut the bracket off the front of the washer bottle as close as possible to the washer bottle for maximum clearance to the air entry hose when installed, Use a die grinder to neaten the cut.

**N.B:** Care must be taken when cutting off the unused bracket, not to cut into the washer bottle reservoir.

Unclip Connector & Washer hose      Marked Cut Line

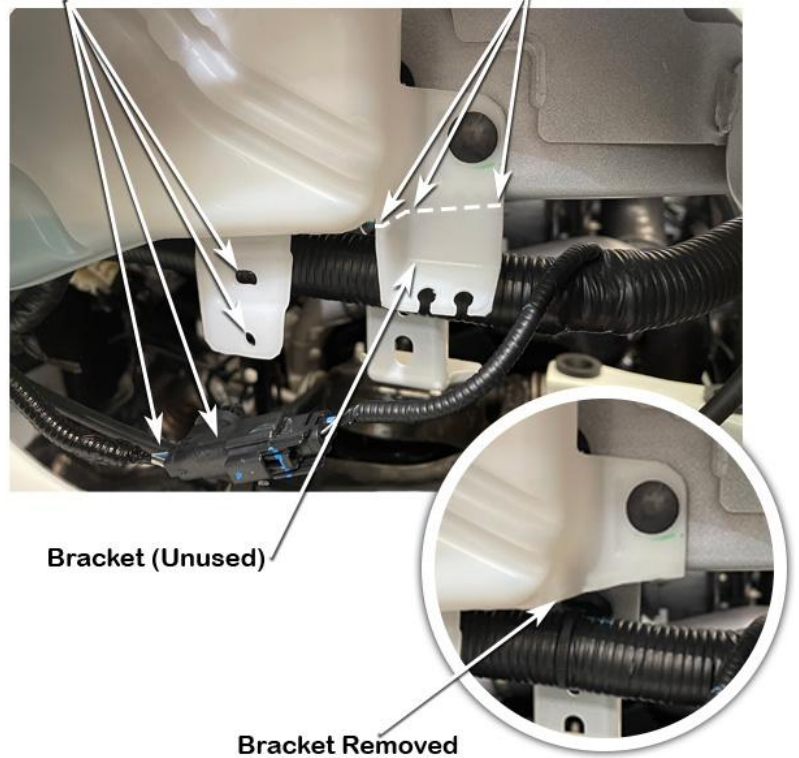

Remove and discard the mounting clip from the washer motor wiring loom connector plug.

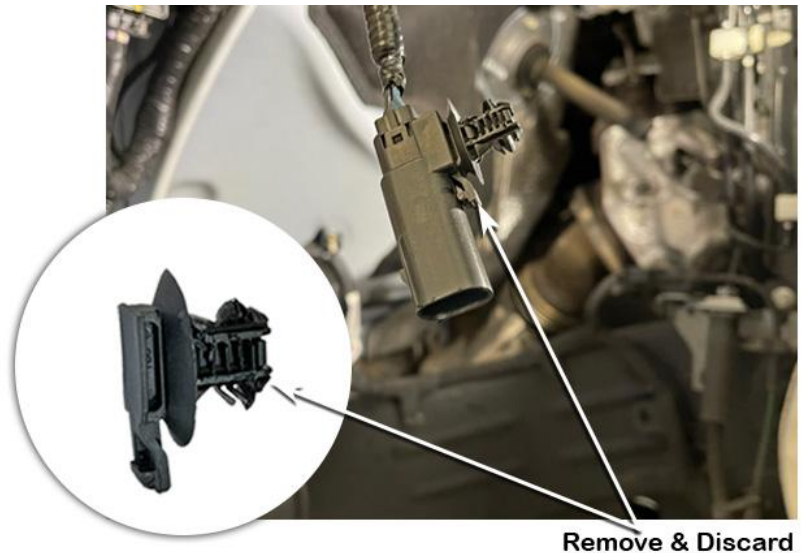

Cable tie the main loom to the vehicle's top structure rail using the large cable tie (Item 23) as shown.



**Vehicles with Front Camera Washer only:**

Measure and mark a hole position approximately 15mm forward of the slot shown.

Drill a pilot hole at the marked hole position. Drill the hole to 6.5mm using a 6.5mm drill bit.

Deburr and paint hole to prevent rust.

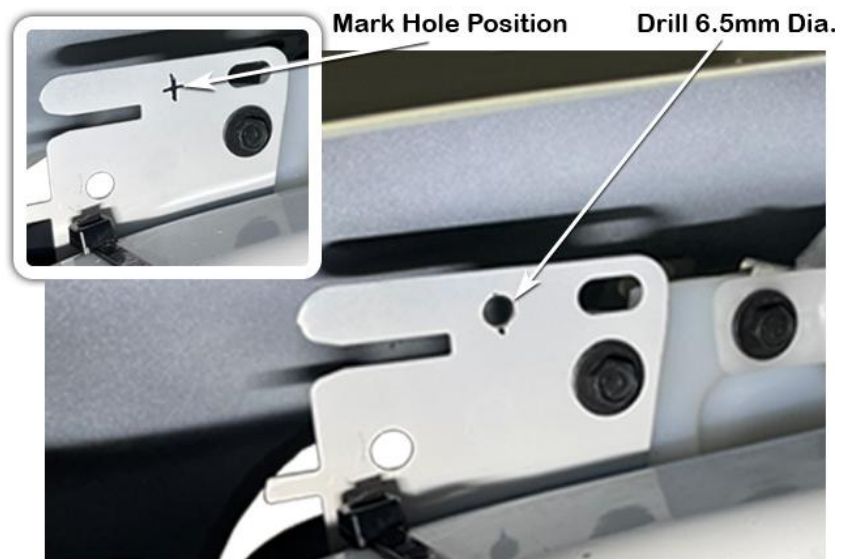

**Vehicles with Front Camera Washer only:**

Remove and reposition the washer hose mounting clip to the new mounting hole location and secure as shown. Place a piece of tape to hold the washer hose to the side of the washer bottle as shown.



Re-connect the washer motor wiring connector plugs and re-route the washer motor wiring harness along the main wiring harness, securing the washer motor wiring harness with cable ties (Item 24) along the main wiring harness as shown.

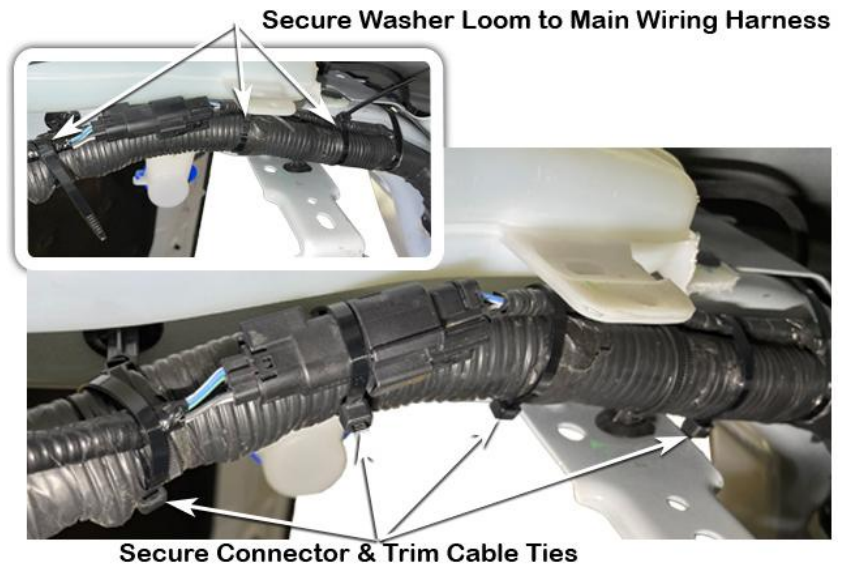

Cut the air cleaner inlet duct from the air cleaner base as marked and indicated.

Remove and discard the standard air cleaner Inlet duct.



With a paint pen marker, mark the remaining protruding inlet plastic and front ribs on the air cleaner base as shown.

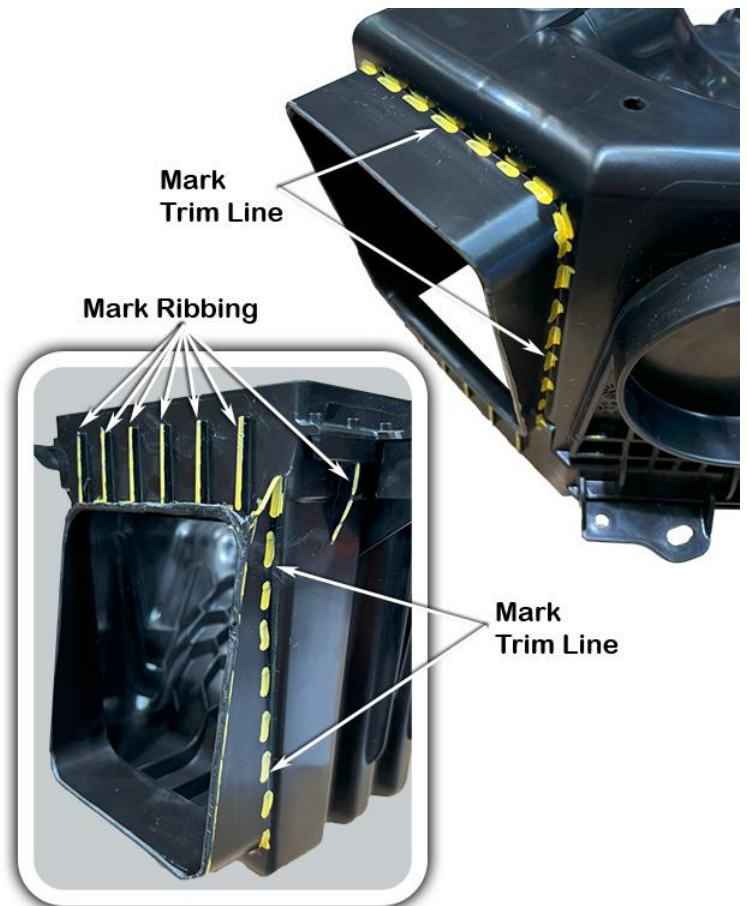

Using the body saw, hacksaw and/or die grinder, neatly remove the remaining marked inlet plastic & ribbing flush with the front of the air cleaner base as shown.

***N.B: Ensure to cut the remaining inlet plastic off flush with Air Cleaner Base front face.***

**Do Not cut around inlet shape.**

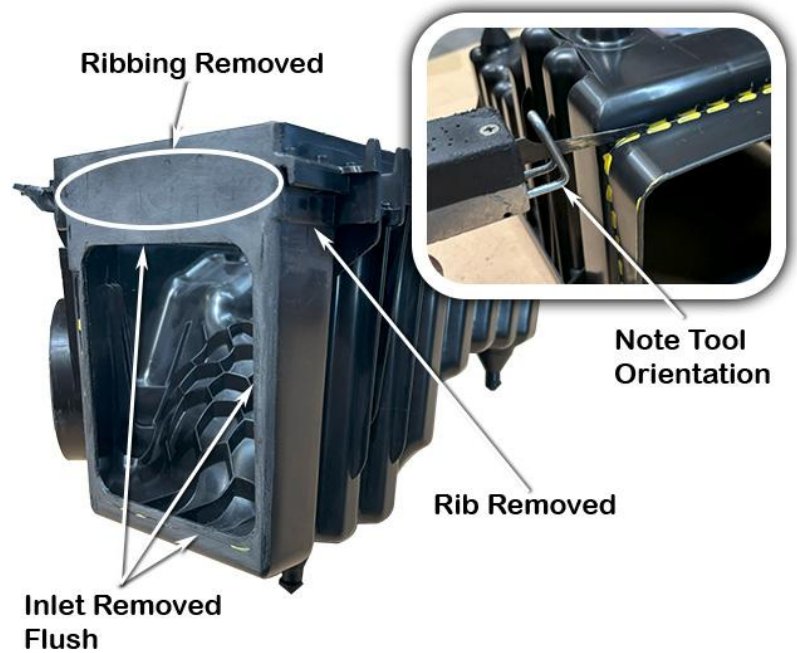

Using a paint pen marker, mark the side ribs on the air cleaner base as shown.

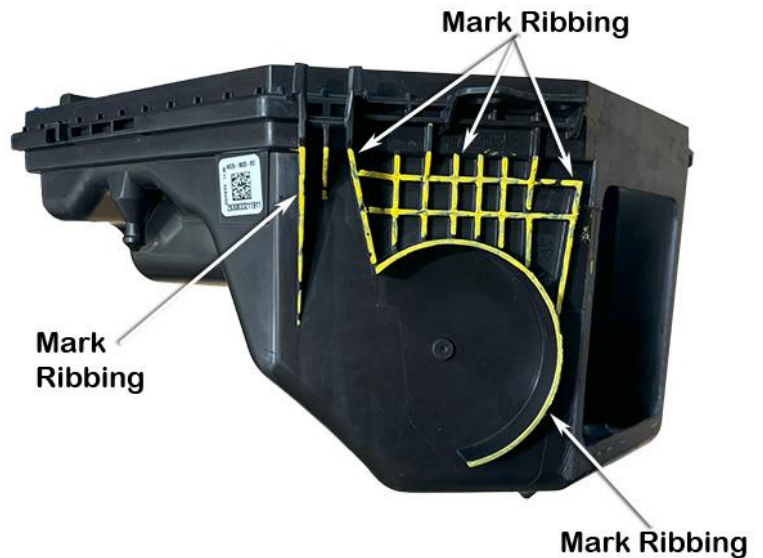

Using a body saw, hacksaw blade, cutting pliers and/or die grinder, neatly remove the highlighted ribs from the side of the air cleaner base as shown.

***Hint: Remove Plastic Air Cleaner Lid Clips from base as to not damage them during ribbing removal process.***

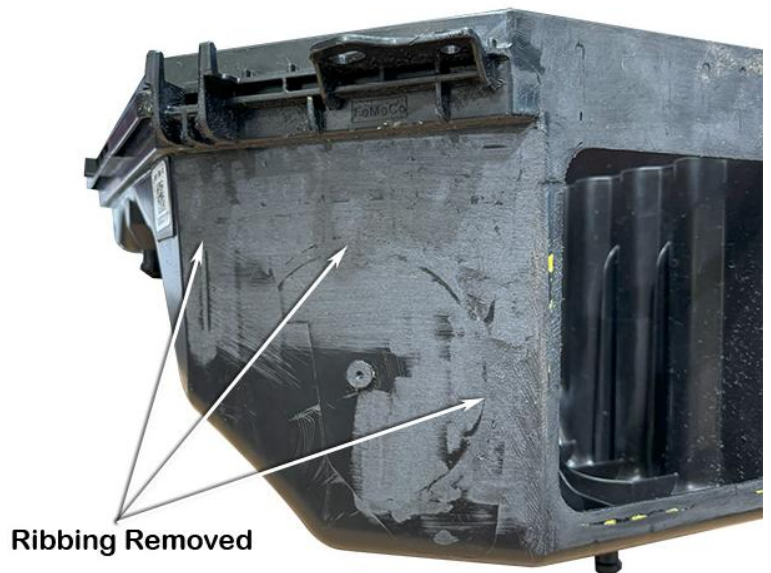

Align the Side Template (Item 27) to the under edge, cut factory inlet opening and edge of QR code plastic pad of the air cleaner base as shown.

Ensure to form template closely to shape of air cleaner base.

Tape template into position.

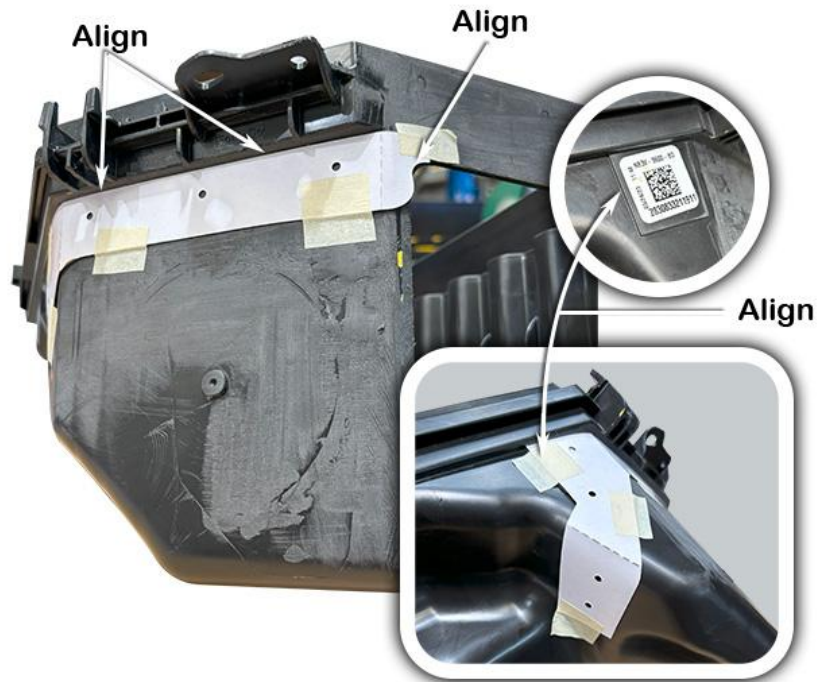

Align the front template (Item 25) to the upper edge, side clip ribbing and factory inlet cut opening of the air cleaner base as shown.

Tape template into position.

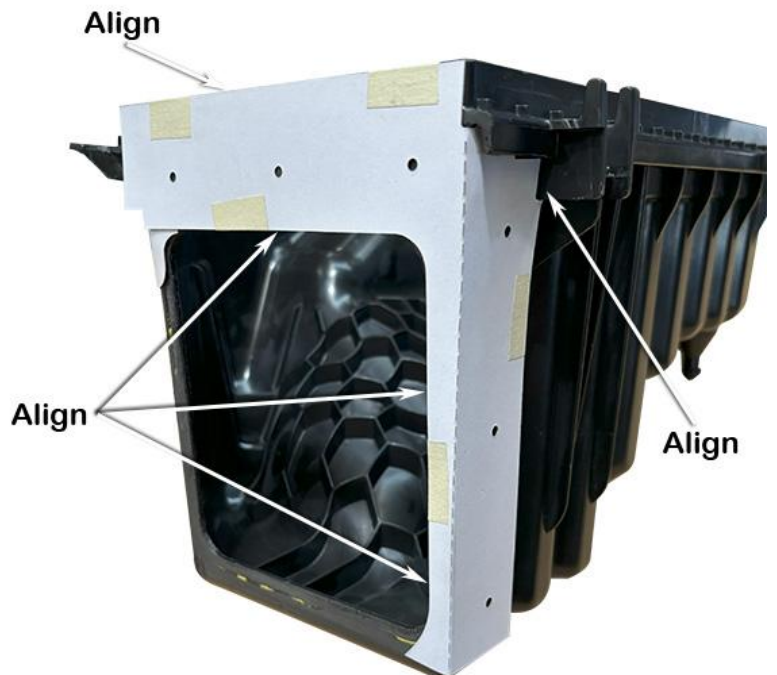

Align the bottom-rear template (Item 28) to the air cleaner base.

Firstly, Align the template to the front & rear lower mount pegs.

Secondly, fold the side tab down and align to the side of the airbox base, as shown.

Ensure to form the template closely to the profile surface of the air cleaner base.

Tape template into position.



Align the lower-front template (Item 26).

Firstly, position the lower-front template (Item 26) over the air cleaner base front lower mount peg.

Secondly, align the side hole indicated on the lower-front template (Item 26), with the lower hole in the front template (Item 25), as shown.

Thirdly, align the lower two holes in the lower-front template (Item 26) with the upper two holes of the bottom rear template (Item 28), as shown.

Tape template into position.

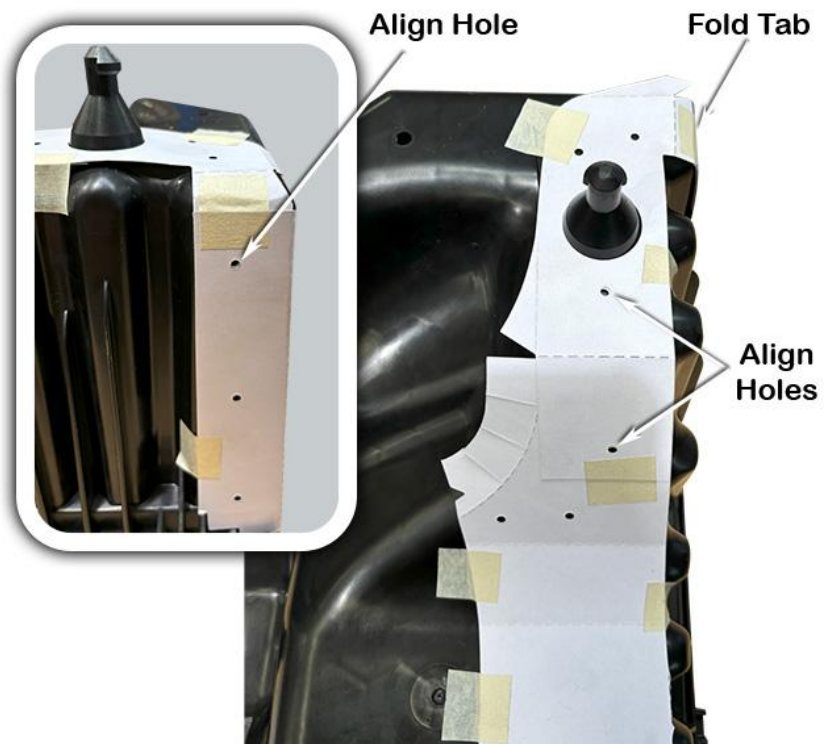

Align the side-intermediate template (Item 29).

Firstly, align the two holes indicated in the side-intermediate template (Item 29) with the two holes in the side template (Item 27), as shown.

Secondly, align the triangle indicator on the side intermediate template (Item 29) with the indicator on the bottom rear template (Item 28), as shown.

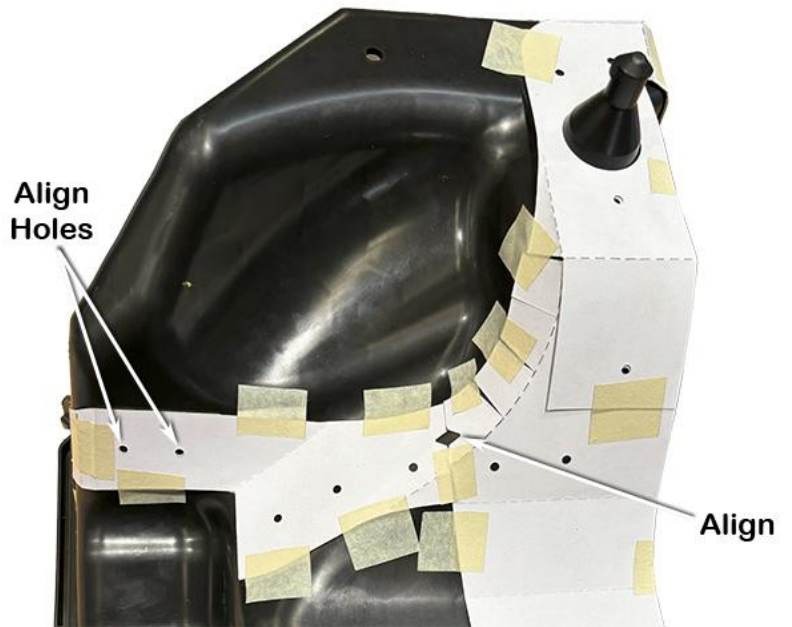

With all five templates aligned, formed & taped onto the air cleaner base, mark all 22 hole positions and the required air cleaner base cut-out.

Remove the templates.

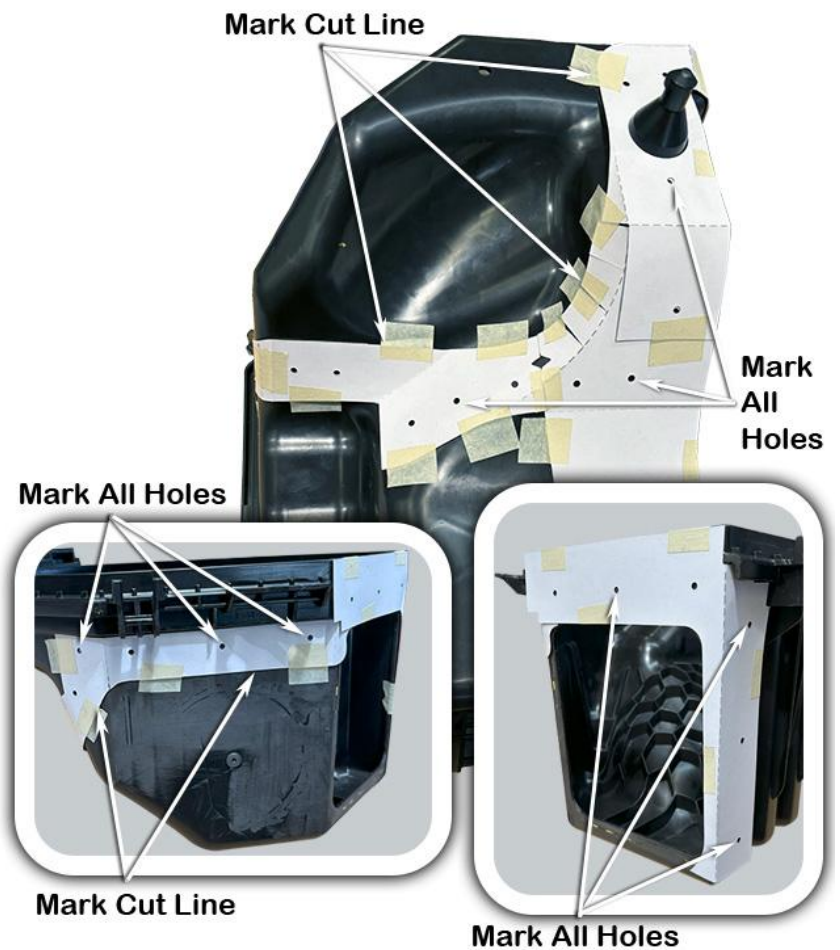

Drill a pilot hole at all 22 marked hole positions, then drill the holes to 4.5mm diameter.

Deburr all holes.

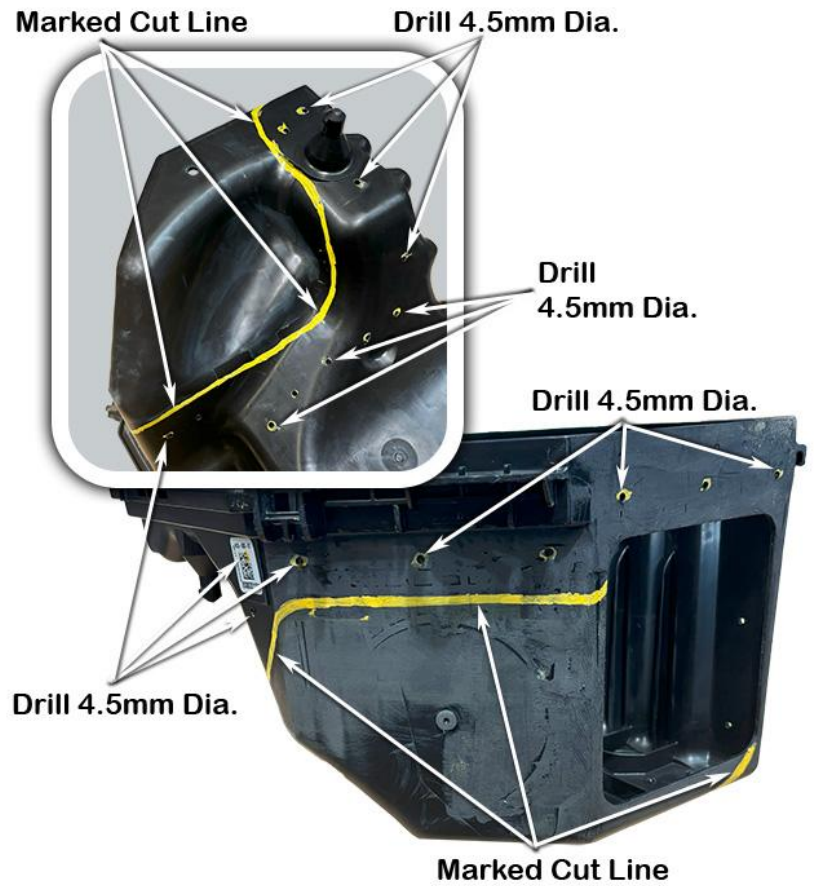

Using a body saw cut the new air cleaner inlet hole, as marked in step 31.

Neaten up the cut using a file or die grinder.

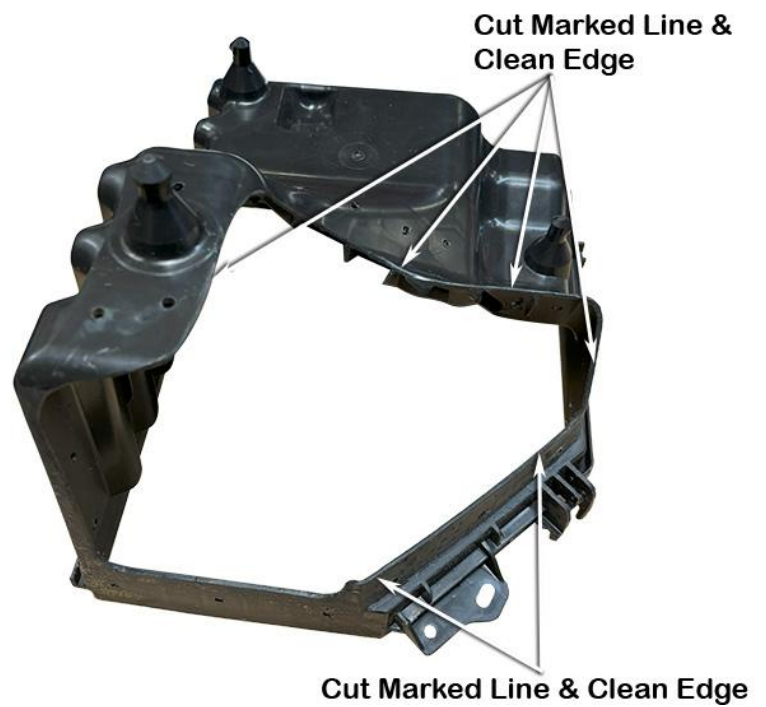

Using a paint pen marker, mark the internal honeycomb ribbing in the air cleaner base where shown.

Using chisel, sharp knife, cutting pliers and/or die grinder, neatly remove the highlighted internal ribbing from the inside of the air cleaner base as shown.

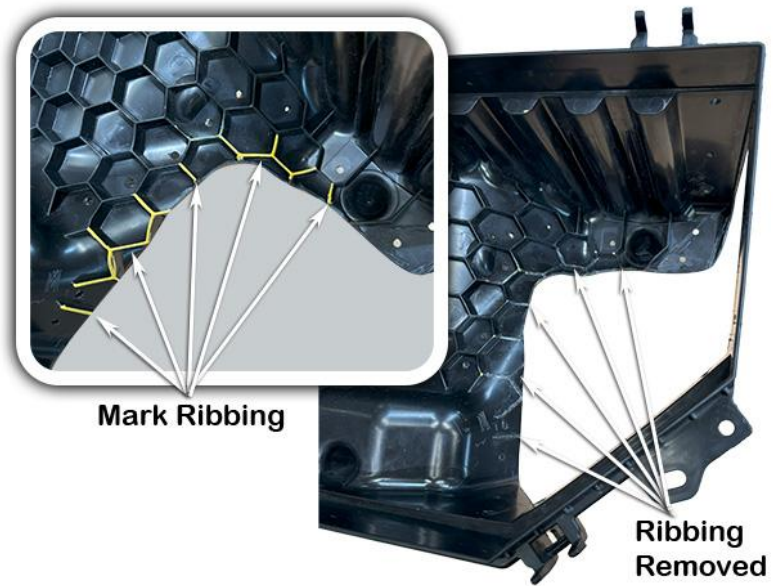

Remove Barcode Sticker from the Air Cleaner Base.



Apply a liberal amount of Sikaflex sealant to the flange of the air cleaner base.

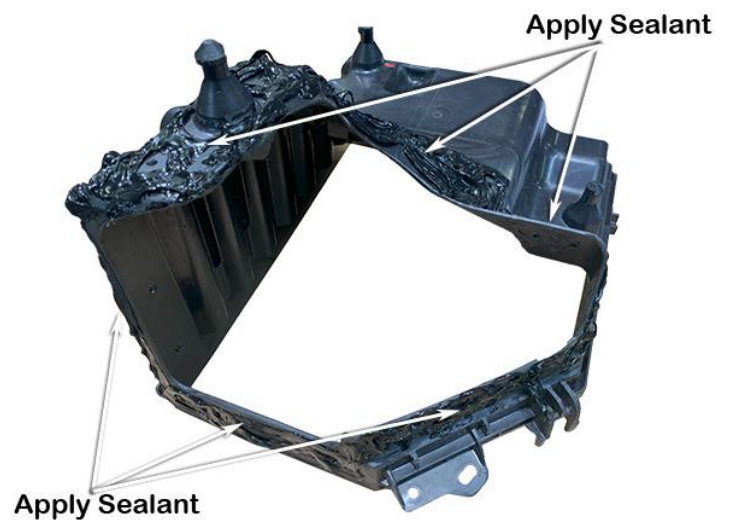

Install the air entry hose (Item 10) onto the air cleaner base.

Position the Front Upper & Side LH hose support plates (Item's 12,13) onto the air entry hose flange.

Install the pop rivets (Item 19) from the inside of the air cleaner base through the air entry hose and clamping plates, as shown.

Secure all pop rivets (Item 19).

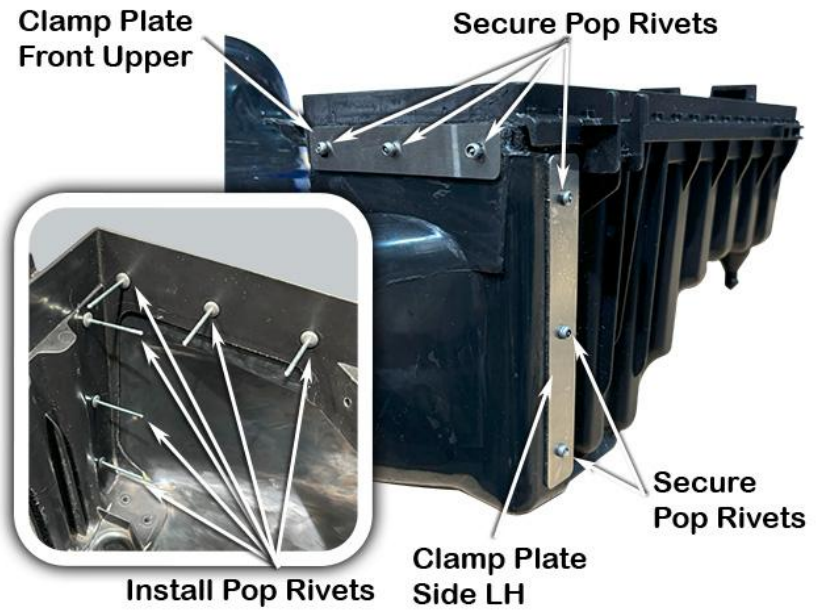

Position the Lower Large, Lower Small 1 & 2 hose support plates (Item's 14,15 & 16) onto the air entry hose flange.

Install pop rivets (Item 19) from the inside of the air cleaner base through the air entry hose and clamping plates, as shown.

Secure all pop rivets (Item 19).

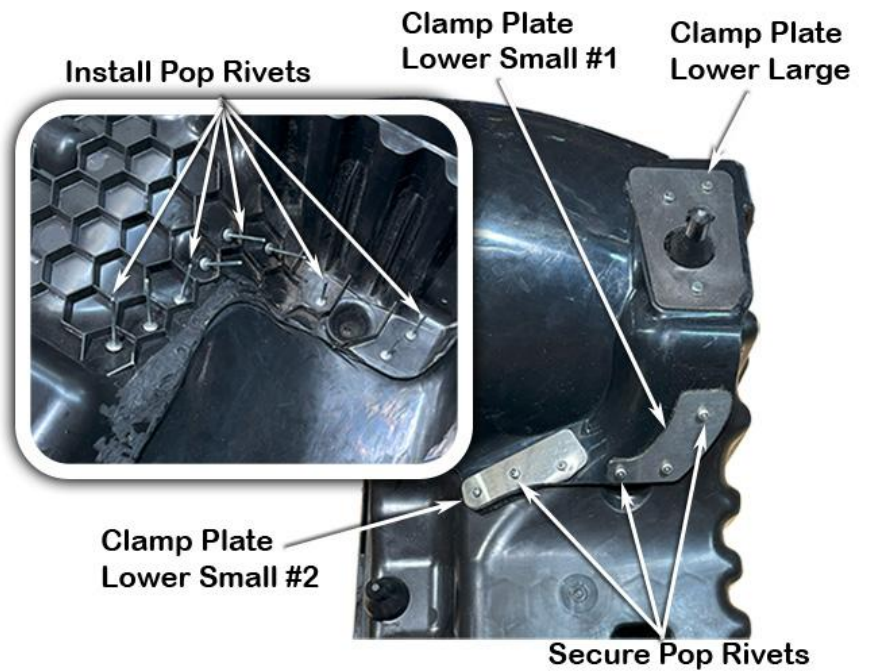

Position the Side/Front Upper hose support plate (Item 11) onto the air entry hose flange.

Install pop rivets (Item 19) from the inside of the air cleaner base through the air entry hose and clamping plates, as shown.

Secure all pop rivets (Item 19).

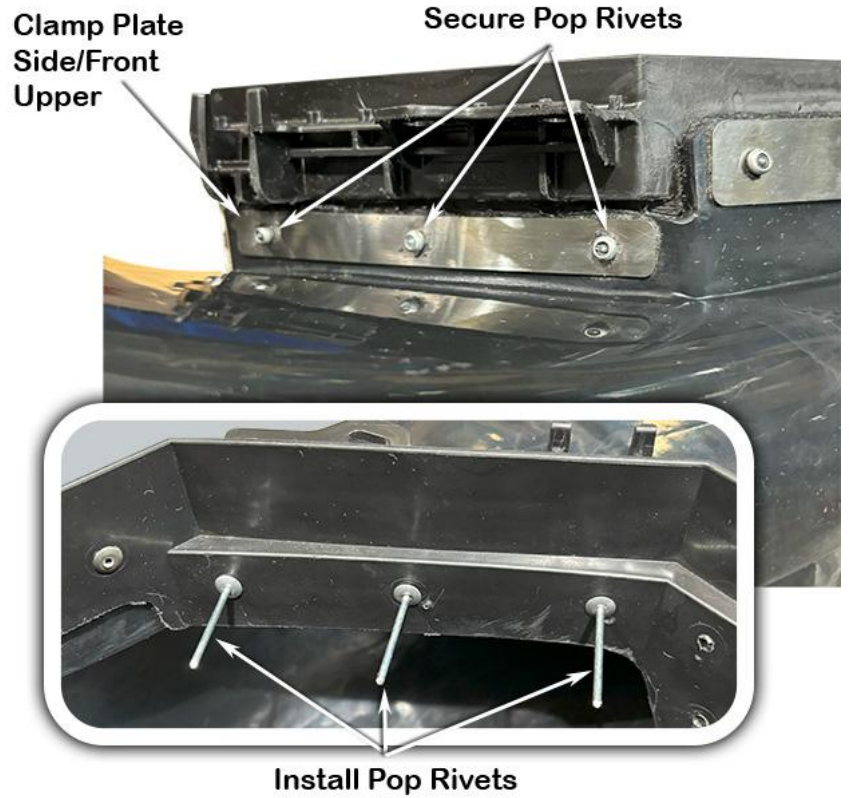

Position the Upper Side hose support plate (Item 18) onto the air entry hose flange.

Install pop rivets (Item 19) from the inside of the air cleaner base through the air entry hose and clamping plates, as shown.

Secure all pop rivets (Item 19).

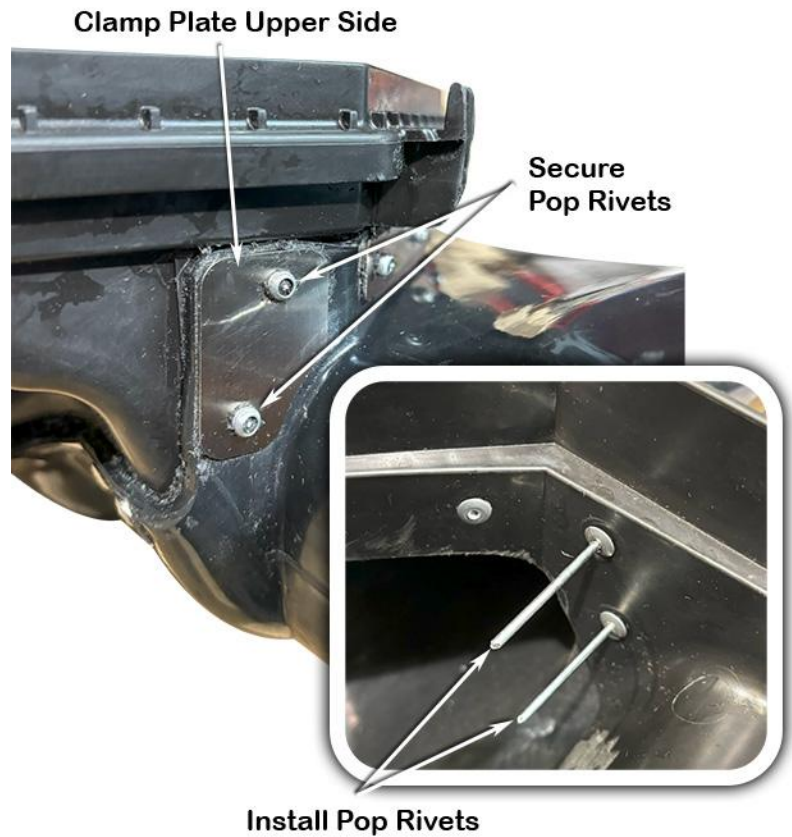

Position the Lower Side hose support plate (Item 17) onto the air entry hose flange.

Install the remaining two pop rivets from the outside of the air cleaner base through the lower-side support plate (Item 17) indicated, along with the M4 body washers (Item 20).

Secure the pop rivets (Item 19).

***N.B: Note the orientation and position of the pop rivets & M4 Body Washers.***

Clean up the Sikaflex sealant on the inside and outside of the air cleaner base to ensure a neat finish.

If required apply more Sikaflex sealant to any areas that require more sealant to ensure the fitment of the hose to the air cleaner base is correctly sealed.

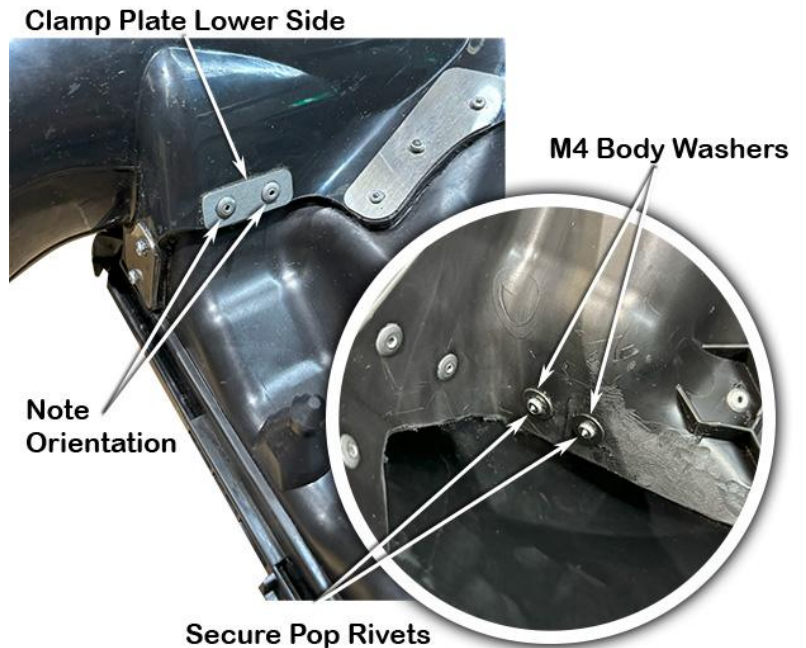

Re-install the air cleaner base into the vehicle, ensuring the mounting pins are correctly installed into the mounting grommets. Install the standard mounting bolt and fasten.

Loosely install the 130/150mm hose clamp (Item 21) to the inlet of the air entry hose (Item 10).

***Note: The orientation of the hose clamp.***



Carefully install the snorkel body (Item 1) to the fender, guiding the snorkel body outlet into the air entry hose (Item 10), align the snorkel body to fender and upper mounting bracket.

When correctly aligned, fasten the snorkel body to the fender with body washers (Item 8) and nyloc nuts (Item 9).

Fasten the snorkel body to the upper mounting bracket with hex bolts (Item 4).



With the air entry hose correctly installed onto the snorkel body outlet snout, tighten the 130/150mm hose clamp (Item 21).

**Note: The orientation of the hose clamp.**



On the inside of the RH Fender Flare, measure 18mm from the base of the central locator pin and mark a line.

Cut the pin at the marked location.

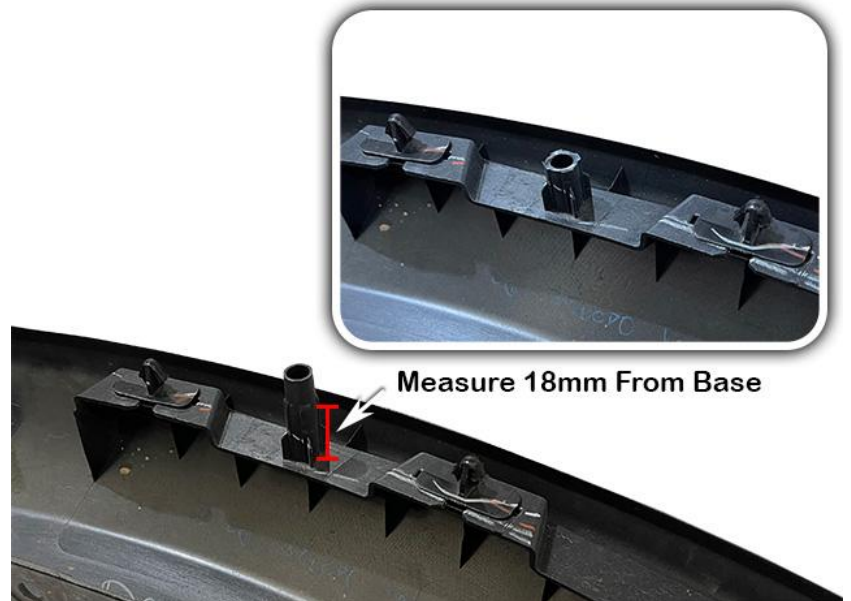

Install both the RH Fender Flare & Secondary Inner Guard Liner back onto the vehicle in accordance with the factory service manual.



47

Install the ARMAX air ram assembly (Item 2) onto the snorkel body. Align the ARMAX air ram assembly mount holes with the four pre-drilled 2mm holes in snorkel body inlet.

Secure the ARMAX air ram (Item 2) to the Snorkel Body (Item 1) with four black self-tapping screws (Item 22).

***N.B: This step can be completed prior to Snorkel Body being fit to vehicle in Step 43.***



48

Re-install the Main Inner guard liner (Main Splash Guard Section), air cleaner element, air cleaner lid, reconnect sensor wiring and any other items that may have been removed during the snorkel installation process.

49

**N.B: It is the installer's responsibility to ensure that all connections are watertight.**