

SS177HFR

SAFARI V-SPEC SNORKEL
 Suits: ISUZU D-Max RG01 TFR/S MY21 – Onwards
 & ISUZU MU-X RJ01 UCR/S MY22 - Onwards
 3.0L Turbo Diesel (4JJ3-TCX Engine)
Incl. MY24 All Models excluding the D-Max Blade
 (Replaces Factory ISUZU Snorkel)



Update 01/12/2024

Parts List

ITEM	PART NO.	DESCRIPTION	QTY
1	741-133-000	BODY - SNORKEL (SS177HF)	1
2	000-135-800	3 ½" AIR RAM ASSEMBLY	1
3	741-032-000	BRACKET - UPPER MOUNTING	1
4	000-002-100	BOLT - HEX - 6mm x 1.0 x 14mm (SEMS)	2
5	000-951	SCREW - S/T - 4.2mm x 13mm - S/S	3
6	000-960	INSERT - PLASTIC	3
7	000-110	STUD - 8mm x 1.25 x 25mm - S/S	6
8	000-311-300	WASHER - BODY - 8mm x 30mm - S/S	6
9	000-205-300	NUT - NYLOC - 8mm x 1.25mm - S/S	6
10	741-435-000	GASKET - A-PILLAR BLANK-OFF PLATE	1
11	741-704-000	PLATE - A-PILLAR BLANK-OFF	1
12	741-024-300	HOSE - SNORKEL OUTLET	1

13	741-025-200	SLEEVE - STAINLESS STEEL - 76.2mm OD x 50mm	1
14	000-908	CLAMP - HOSE - 70/90mm	1
15	000-1911	CLAMP - HOSE - 100/120mm	1
16	000-914/B	CLAMP - HOSE - SIZE 56 (BLACK)	1
17	741-016-000	RUBBER - FENDER INFILL (NON FACTORY FLARE MODELS ONLY)	1
18	741-016-100	** RUBBER – <u>FLARE</u> INFILL (MY24-ONWARDS X-TERRAIN MODELS ONLY)	1
19	741-017-000	TEMPLATE - GUARD PANEL (SS177HF)	1

** = Parts included in latest update, 01/12/2024.



4X4 ENGINEERING

SS177HFR

SAFARI V-SPEC SNORKEL

Suits: ISUZU D-Max RG01 TFR/S MY21 – Onwards
& ISUZU MU-X RJ01 UCR/S MY22 - Onwards
3.0L Turbo Diesel (4JJ3-TCX Engine)

Incl. MY24 All Models excluding the D-Max Blade
(Replaces Factory ISUZU Snorkel)

Installation Guide

Fitment to:

- Right Hand Side

Fitting Time:

- 210min

Special Tools:

- Body Saw (Reciprocating)
- Step Drill
- Files
- Masking Tape
- Loctite 243 (thread lock)
- Touch-up paint
- Sikaflex 227 Adhesive Sealant

Prior to commencing the installation, it is the installer's responsibility to verify that all components and particularly the template (Item 19) are correct.

1 Remove the following in accordance with the factory service manual:

- RHS Mud Flap
- RHS Guard Liner
- Air Cleaner Assembly

2

Remove and discard the Factory Isuzu snorkel components (shown) from the vehicle.

Retain the two screws from the upper mounting bracket as shown.

Do Not removed the plastic inserts from the A-pillar panel.



3

Remove and discard the two perforated sections of the guard panel template (Item 19) as shown.

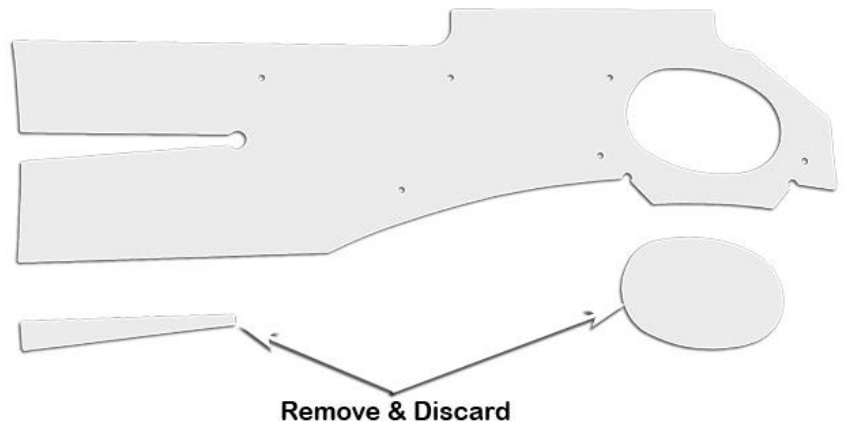

4

Align the guard panel template (Item 19) with the upper corner, upper and rear edges of the RHS guard panel as shown.

Tape the template to the guard panel with masking tape.

Mark all hole positions with a felt tip pen.

Remove the template.

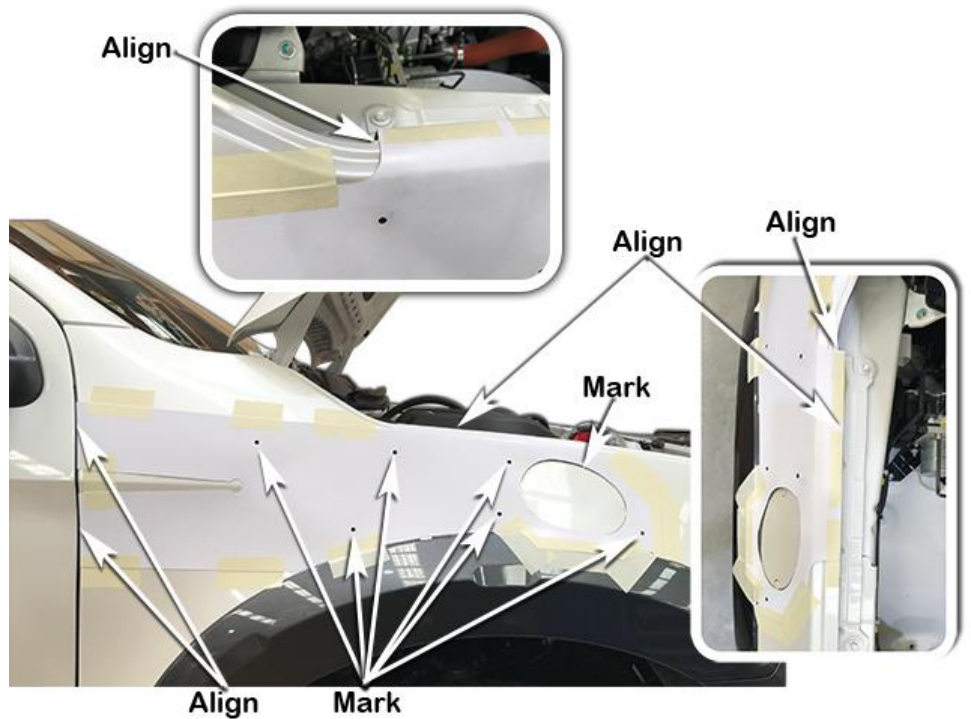

Drill a pilot hole for each of the marked hole positions.

Use a step drill to drill the six mounting holes to 16mm diameter.

Drill 1 or 2, 10mm diameter holes in the cut-out section for a start/stop point for the body saw, using the body saw cut the main hole in the guard panel as marked from the template cut-out in step 4.

Deburr and paint all holes. It may also be necessary to re-paint the existing holes in the guard panel.

Hint: Vehicles fitted with factory flares, tape the flare and guard panel joint to prevent any metal filings becoming trapped between the flare and guard seal.

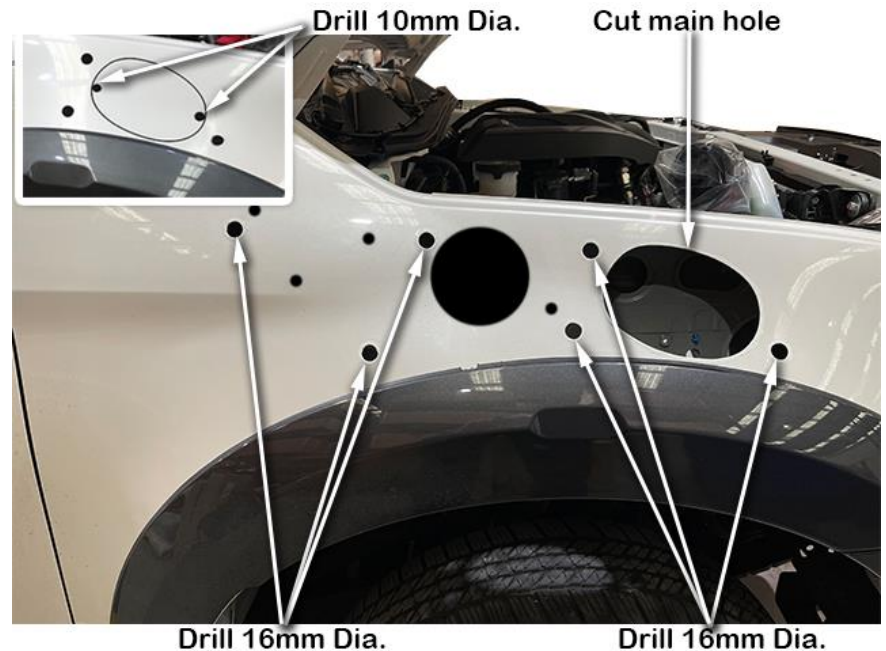

NEW ZEALAND INSTALLATIONS ONLY :

Safari have developed 2 methods of Snorkel A pillar attachment, for the conventional method please proceed with the current document alternatively please see the link below for further instructions.

www.safari4x4.co.nz/apillarmounting

Install the upper mounting bracket (Item 3) to the snorkel body (Item 1) with hex bolts (Item 4).

Apply Loctite 243 to each of the stainless steel mounting studs (Item 7) and install the studs finger tight into the snorkel body (Item 1) mounting inserts as shown.

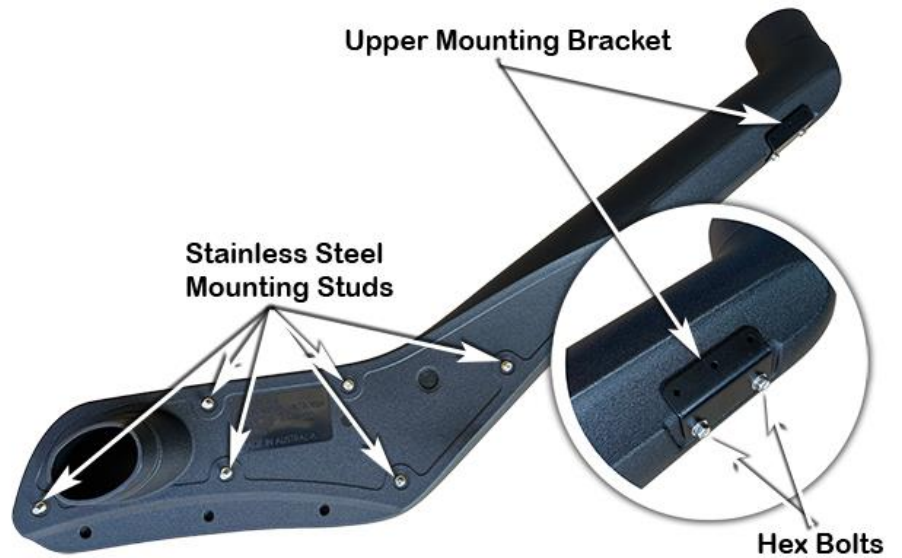

Non Factory Flare Models Only:

Apply Sikaflex adhesive sealant to the lower section of the snorkel body as shown.

Install the fender infill rubber (Item 17) to the snorkel body (Item 1), tape the infill rubber to the snorkel body in several positions to hold the infill rubber in position while the adhesive sealant cures.

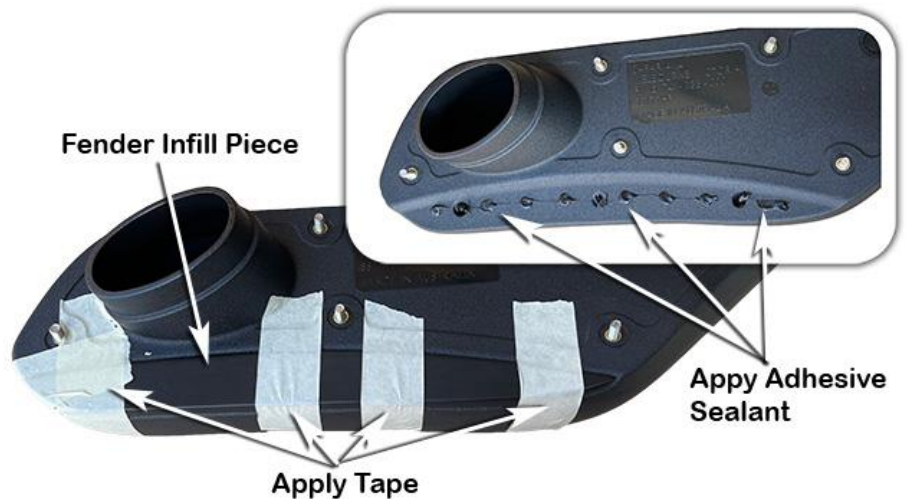

X-Terrain **MY24-Onwards** **Models Only:**

Apply Sikaflex adhesive sealant to the Rubber Flare Infill Piece (Item 18) as shown.

Install the Rubber Flare Infill Piece (Item 18) to the snorkel body (Item 1) aligning the front and lower edges, as shown.

Hint: Tape the infill rubber to the snorkel body in several positions to hold the infill rubber in position while the adhesive sealant cures.



Place a strip of masking tape along the A-pillar panel.

Carefully install the snorkel body (Item 1) to the guard panel.

With the snorkel body correctly positioned, mark the outline of the upper mounting bracket (Item 3) onto the masking tape.

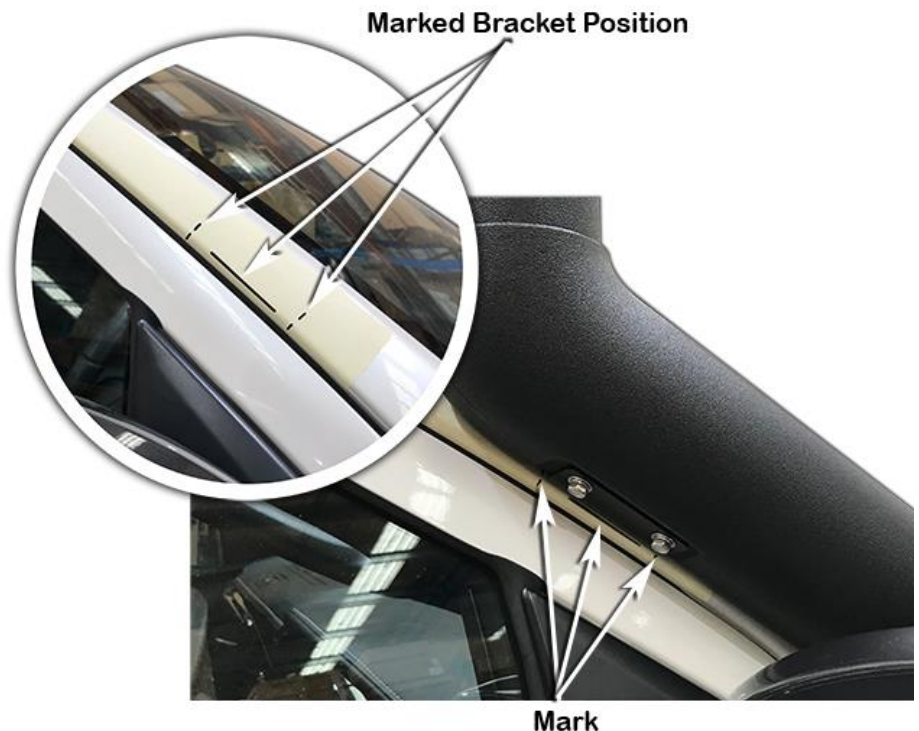

Remove the snorkel body (Item 1) from the vehicle and remove the upper mounting bracket (Item 3) from the snorkel body.

Position the upper mounting bracket (Item 3) onto the A-pillar and align the bracket with the marked bracket outline.

Mark the three mounting hole positions with a felt tip pen.

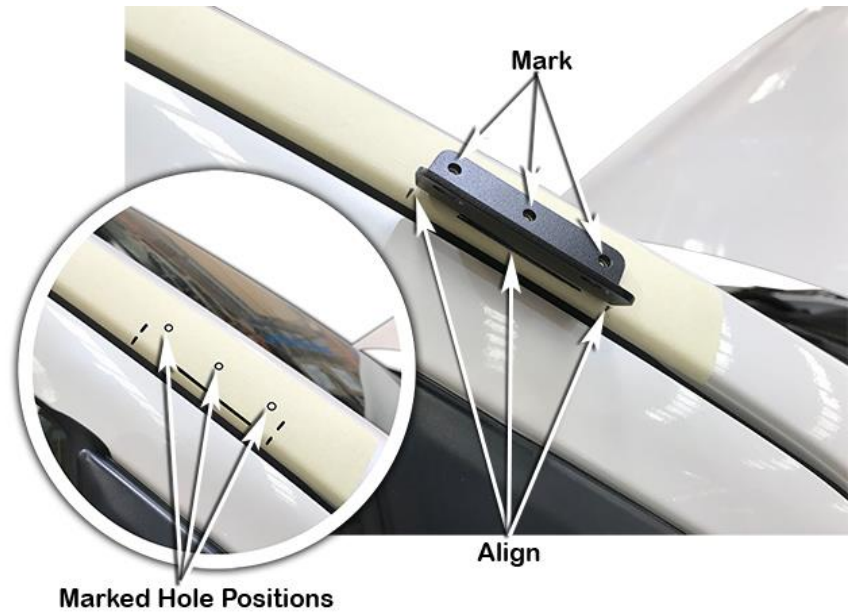

Drill a pilot hole at each of the three marked hole positions. Drill each hole position to 8mm diameter with a step drill or 8mm drill bit.

Deburr and paint holes to prevent rust.



Install the plastic inserts (Item 6) into the 8mm diameter holes in the A-pillar.

Secure the upper mounting bracket (Item 3) to the A-pillar with three self-tapping screws (Item 5).

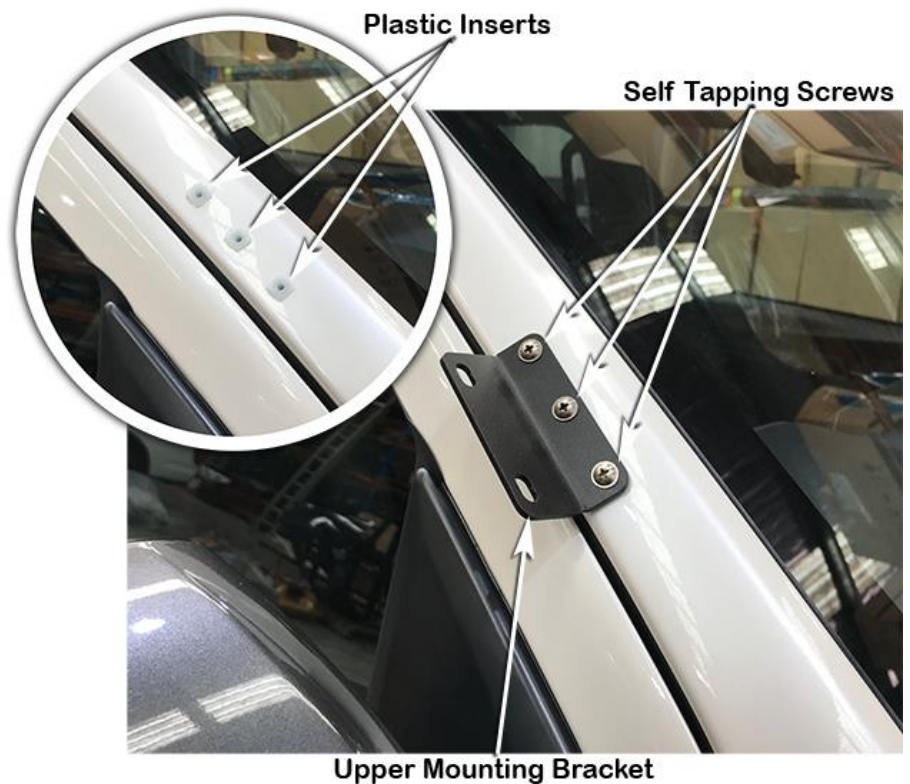

Install the rubber gasket (Item 10) and blank-off plate (Item 11) to the two factory snorkel plastic inserts in the A-pillar panel.

Secure the blank-off plate and rubber gasket to the A-pillar panel with the two self tapping screws retained in step 2.



The inlet snout of the factory snorkel air cleaner base needs to be modified.

Measure and mark a cut line 40mm in from the end of the inlet snout as shown.



Using the body saw or hack saw cut-off and discard the 40mm section from the air cleaner base inlet snout as marked in step 13.

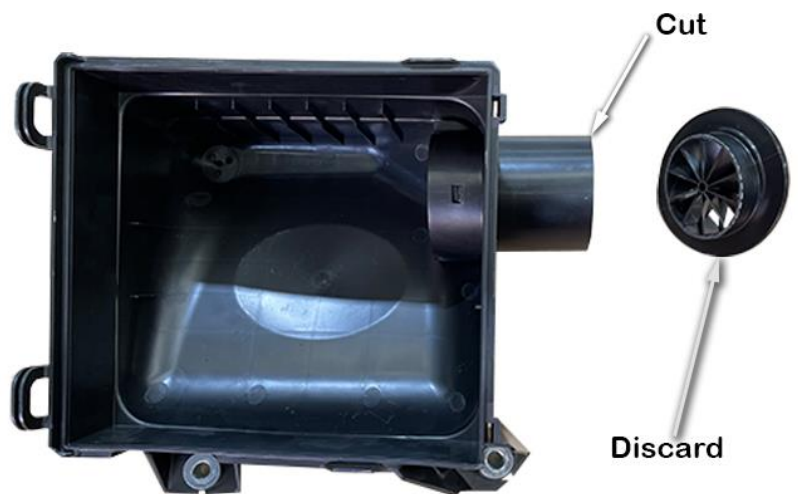

The internal tube of the inlet snout must be removed, using a drift and a hammer, gently tap the end of the tube to break the plastic welds retaining the internal tube.

Discard the internal tube.

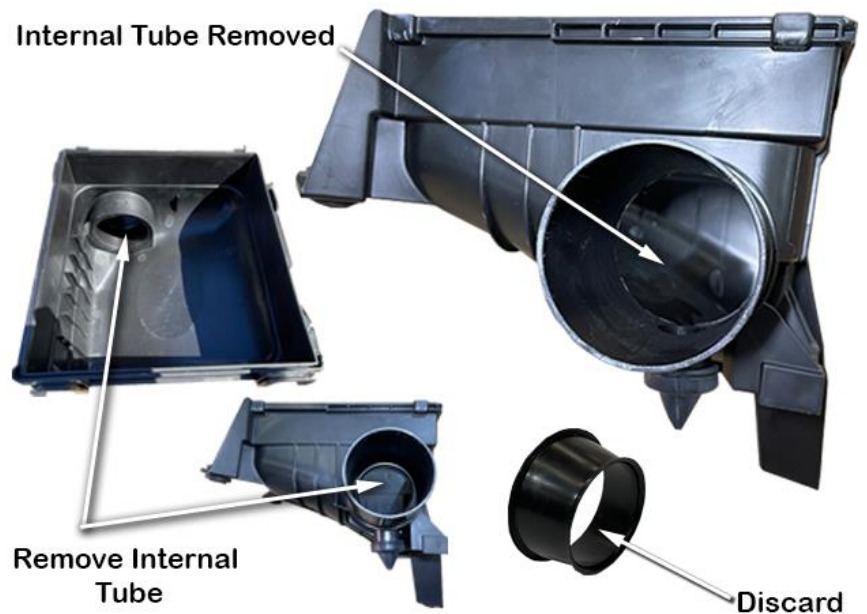

The air cleaner inlet must be sealed by the installer.

Carefully dismantled the air cleaner inlet snout from the air cleaner base.

Apply Sikaflex adhesive sealant to the joint and then reassembled.

Clean-up any excess sealant to ensure a neat finish.

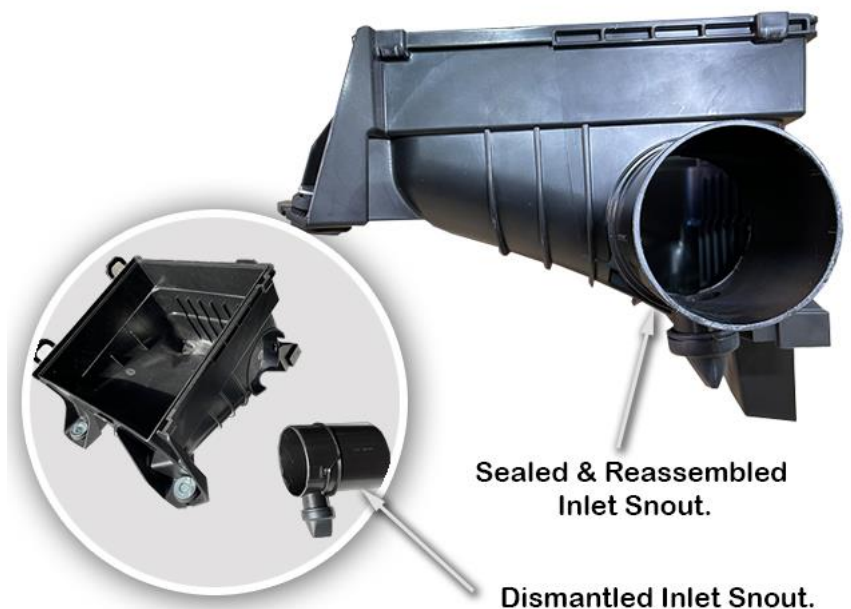

INSTALLER OPTION :

The air cleaner housing base contains two drain valves as shown. The drain valves can permit water to enter the air intake.

Safari advises that the drain valves should be sealed to ensure a watertight installation.



Apply Sikaflex adhesive sealant to the inlet snout and stainless steel sleeve (Item 13).

Install the stainless steel sleeve (Item 13) into the air cleaner inlet snout, flush with the end of the inlet.

Clean-up any excess sealant to ensure a neat finish.



Re-install the air cleaner base and fasten using the standard mounting bolts.

Install the snorkel outlet hose (Item 12) through the hole in the inner guard panel, loosely install a 70/90mm hose clamp (Item 14) onto the hose and install the snorkel outlet hose onto the air cleaner inlet snout.

Slightly tighten the 70/90mm hose clamp, so the hose is still able to be rotated.

Snorkel Outlet Hose

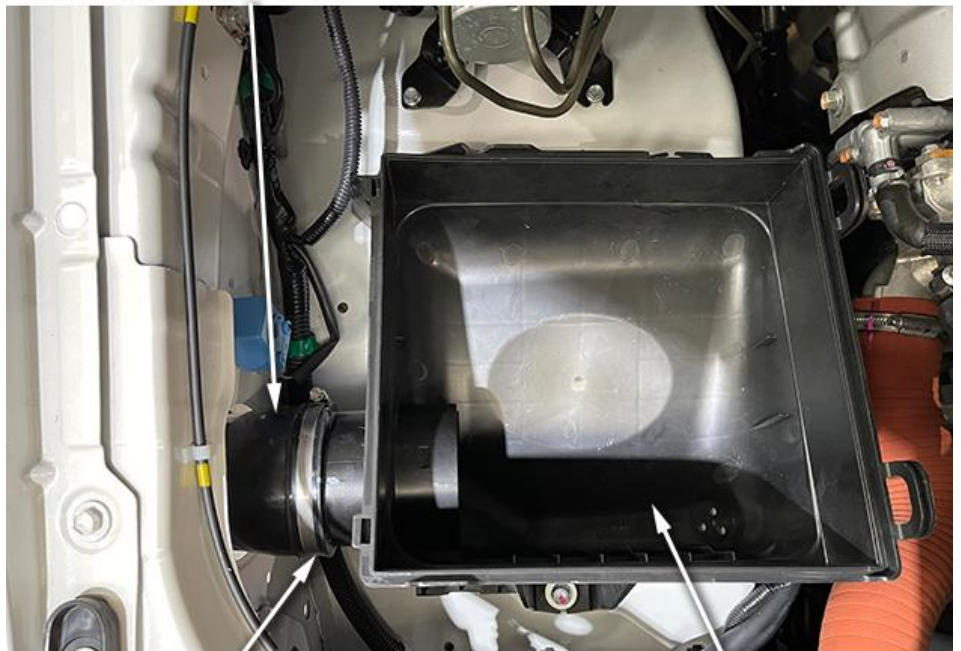

70/90mm Hose Clamp

Air Cleaner Base

Orientate the snorkel outlet hose to the main hole in the guard panel as shown.

Carefully shape the 100/120mm hose clamp (Item 15) to the oval shape of the snorkel outlet hose (Item 12).

Note: The orientation of the hose clamp.

Apply a small amount of lubricant to the inside of the snorkel outlet hose.

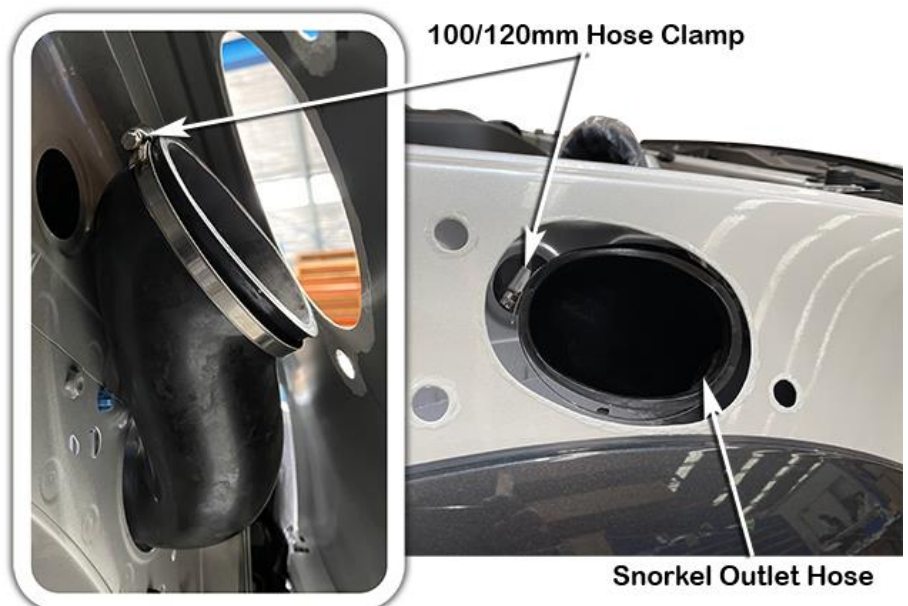

100/120mm Hose Clamp

Snorkel Outlet Hose

Carefully install the snorkel body (Item 1) to the guard panel, guiding the snorkel body outlet snout into the snorkel outlet hose (Item 12), align the snorkel body to guard panel and upper mounting bracket.

When correctly aligned, fasten the snorkel body to the guard panel with body washers (Item 8) and nyloc nuts (Item 9).

Fasten the snorkel body to the upper mounting bracket with hex bolts (Item 4).



Ensure the snorkel outlet hose is correctly installed onto the snorkel body outlet snout and tighten the 100/120mm hose clamp (Item 15).

Ensure the snorkel outlet hose is correctly installed onto the air cleaner base inlet snout and tighten the 70/90mm hose clamp (Item 14).

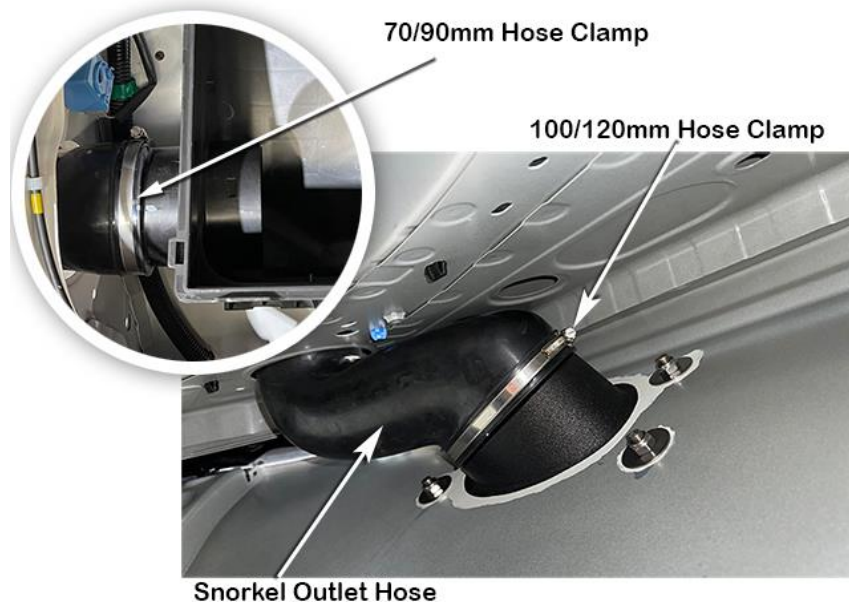

Loosely install the black hose clamp (Item 16) over the base of the air ram assembly (Item 2).

Install the air ram assembly onto the snorkel body.

Align the air ram assembly and tighten the black hose clamp (Item 16).



Install the RHS guard liner, mud flap, air cleaner element, air cleaner lid, reconnect sensor wiring and any other items that may have been removed during the snorkel installation process.

N.B: It is the installer's responsibility to ensure that all connections are water tight.