



SS89HPOER

SAFARI ARMAX OE REPLACEMENT KIT
To Suit: Toyota LandCruiser 200 Series (MY16 Facelift)
4.5L V8 Twin Turbo Diesel (1VD-FTV Engine)
N.B: Suits Models with Factory Toyota Raised Air Intake



19/04/2017

Parts List

SS89HPOER Components

ITEM	PART NO.	DESCRIPTION	QTY
20	370-967-400	PANEL - GUARD INFILL - S/S	1
21	000-958-525	POP RIVET - 4.8mm x 10mm	5
22	000-959-600	PLASTIC PLUG - 25mm Diameter	1
23	370-704-000	PLATE - BLANK-OFF (A-PILLAR)	1
24	370-435-200	RUBBER GASKET	1
25	370-017-700	TEMPLATE - GUARD PANEL INFILL	1

SS89HP Components

ITEM	PART NO.	DESCRIPTION	QTY
1	370-133-600	BODY - SNORKEL (SS89HP)	1
2	000-135-960	4" AIR RAM ASSEMBLY	1
3	370-032-600	BRACKET - UPPER MOUNTING	1
4	000-002-100	BOLT - HEX - 6mm x 1.0 x 14mm (SEMS) - S/S	2
5	000-951	SCREW - S/T - 4.2mm x 13mm - S/S	3
6	000-960	INSERT - PLASTIC	3
7	000-110	STUD - 8mm x 1.25 x 25mm - S/S	6
8	000-376	WASHER - RUBBER - 8mm x 33mm x 3mm	6
9	000-311-300	WASHER - BODY - 8mm x 30mm - S/S	6
10	000-205-300	NUT - NYLOC - 8mm x 1.25mm - S/S	6
11	370-024-200	HOSE - AIR ENTRY	1
12	000-910	CLAMP - HOSE - 90/110mm - S/S	1
13	000-1913	CLAMP - HOSE - 120/140mm - S/S	1
14	000-1931/B	CLAMP - HOSE - SIZE 64 (BLACK)	1
15	370-016-600	GASKET - FOAM BODY (SELF ADHESIVE)	1
16	370-017-600	TEMPLATE - GUARD PANEL	1



SS89HPOER

SAFARI ARMAX OE REPLACEMENT KIT
To Suit: Toyota LandCruiser 200 Series (MY16 Facelift)
4.5L V8 Twin Turbo Diesel (1VD-FTV Engine)
N.B: Suits Models with Factory Toyota Raised Air Intake

Installation Guide

Fitment to:

- Right Hand Side

Fitting Time:

- 210min

Special Tools:

- Body saw (reciprocating)
- Step drill
- 5.5mm & 6.5mm Drill Bits
- Die Grinder
- Files
- Pop Rivet Gun
- Loctite 243 (thread lock)
- Sikaflex 227 Adhesive Sealant
- Touch-up paint
- Prep-wash
- Masking tape

Prior to commencing the installation, it is the installer's responsibility to verify that all components and particularly the templates (Item's 16 & 25) are correct.

1

Note: SS89HP Safari Armax Snorkel Kit needs to be purchased separately to the SS89HPOER for the installation.

Discard the SS89HP instructions from the SS89HP Snorkel Kit and use the SS89HPOER instructions supplied for the installation.

2

Remove the RHS mud flap, inner guard liner, guard mounted indicator (it fitted to vehicle) and the air cleaner assembly in accordance with the factory service manual.

Remove and discard the Factory Toyota Raise Air Intake components (shown).

The following hardware must be retained, two A-pillar bracket mounting bolt assemblies as shown.



Align the guard panel infill template (item 25) to the four standard holes in the right hand guard panel as shown.

Tape the template to the guard panel with masking tape.

Mark all five hole positions with a felt tip pen.

Remove the template.

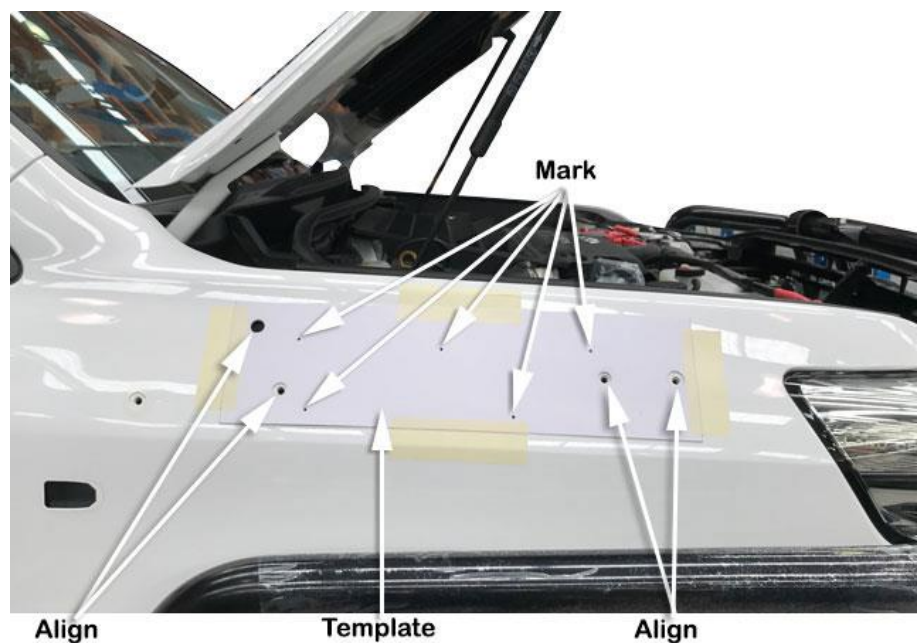

Drill a pilot hole for each of the marked hole positions, drill the five hole positions to 5.5mm diameter using a 5.5mm drill bit.



The front factory captive mounting nut assembly must be removed.

The assembly is spot welded to the guard panel in two places.

Drill a pilot hole in the centre of each spot welds, drill out the spot welds using a 6.5mm drill bit or spot weld drill bit.

Use a small pry bar or flat blade screwdriver to break the spot welds from the guard panel, remove and discard the mounting nut assembly.

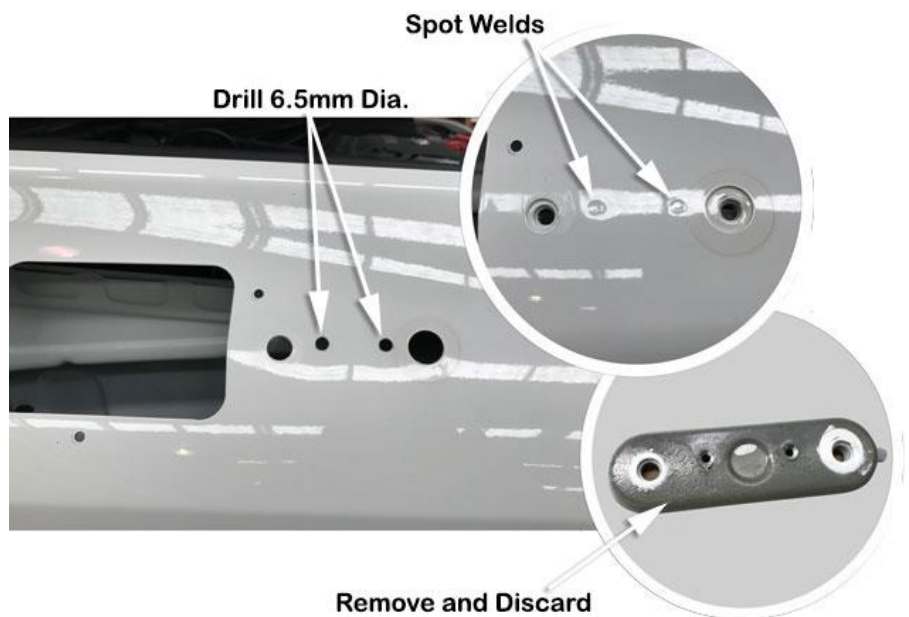

Remove and discard the perforated section of the guard panel template (item 16) as shown.

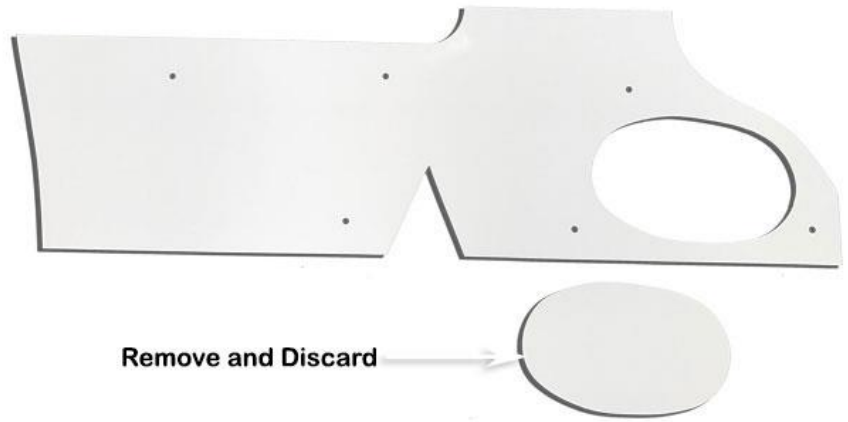

Align the guard panel template (item 16) to the upper and rear edges of the right hand guard panel as shown.

Tape the template to the guard with masking tape.

Mark the four mounting hole positions and the guard panel cut out section with a felt tip pen as shown.

Remove the template.

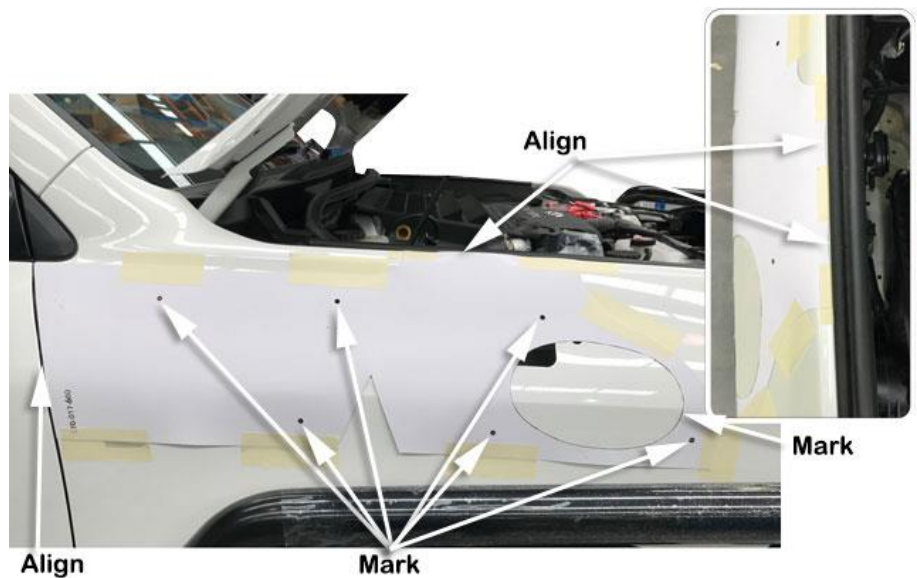

Marked mounting hole positions and guard panel cut out.

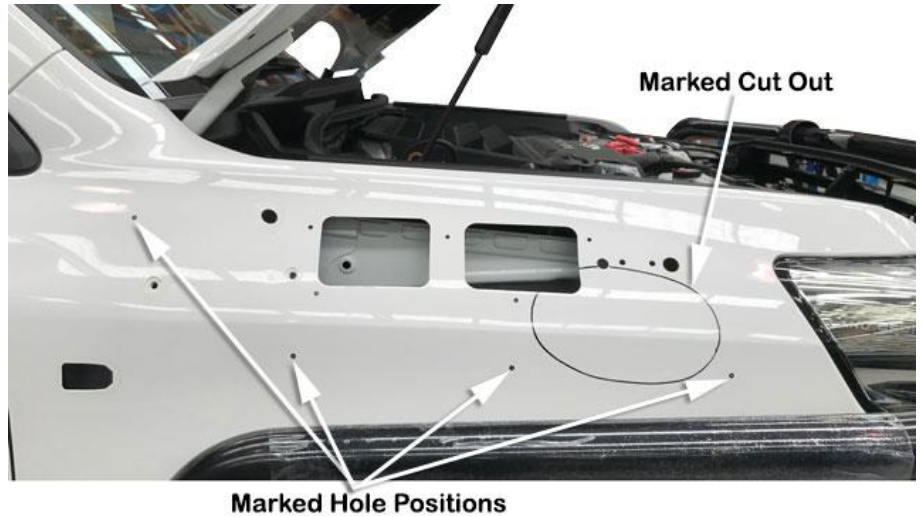

Drill a pilot hole for each of the marked hole positions.

Use a step drill to drill the 4 mounting holes to 16mm diameter.

Using the body saw cut the main hole in the guard panel as marked from the template cut out in step 7.

Deburr and paint all holes and cut sections of guard panel to prevent rust.

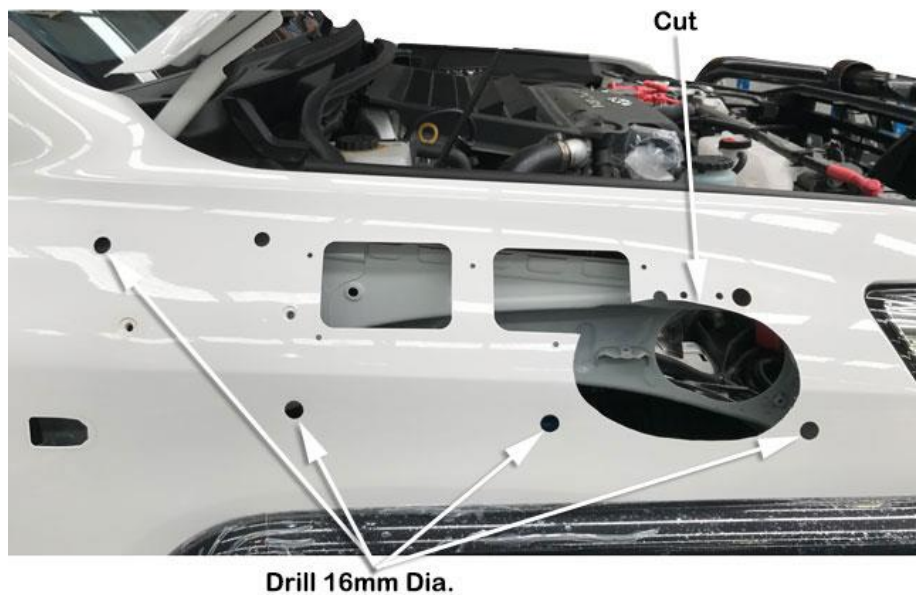

Trial fit the guard infill panel (item 20) and all five 4.8mm x 10.0mm pop rivets (item 21) to the guard panel. If necessary, run the 5.5mm drill bit back through any of the holes which are not aligning up correctly to the infill panel.

Deburr and repaint any of the 5.5mm holes if necessary.

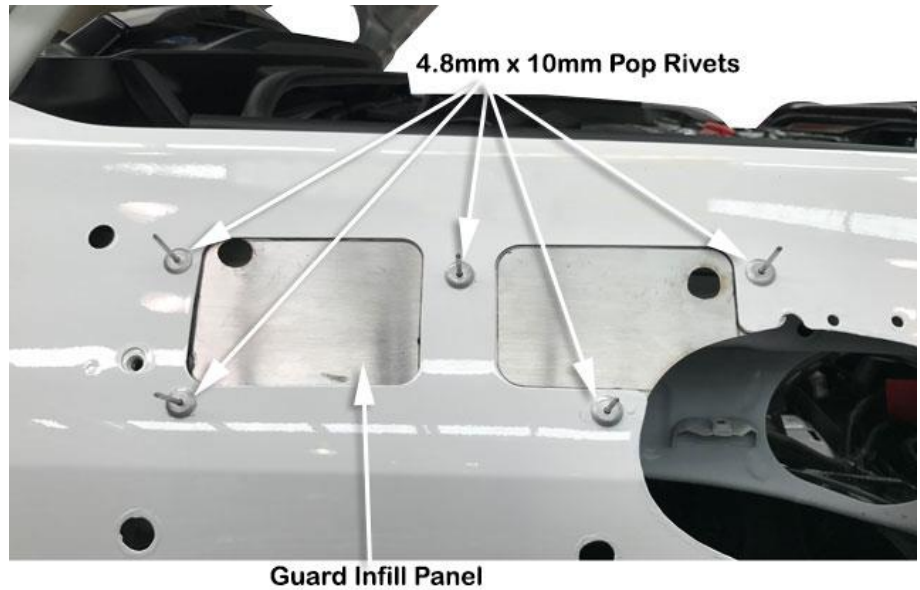

Apply Sikaflex 227 to the outer edges and centre of the guard infill panel (item 20) as shown, install the infill panel to the guard panel, install all 5 pop rivet (item 21).

With the infill panel and all five pop rivets installed, secure the pop rivets using the pop rivet gun.

Clean up any excess sealant to ensure a neat finish.

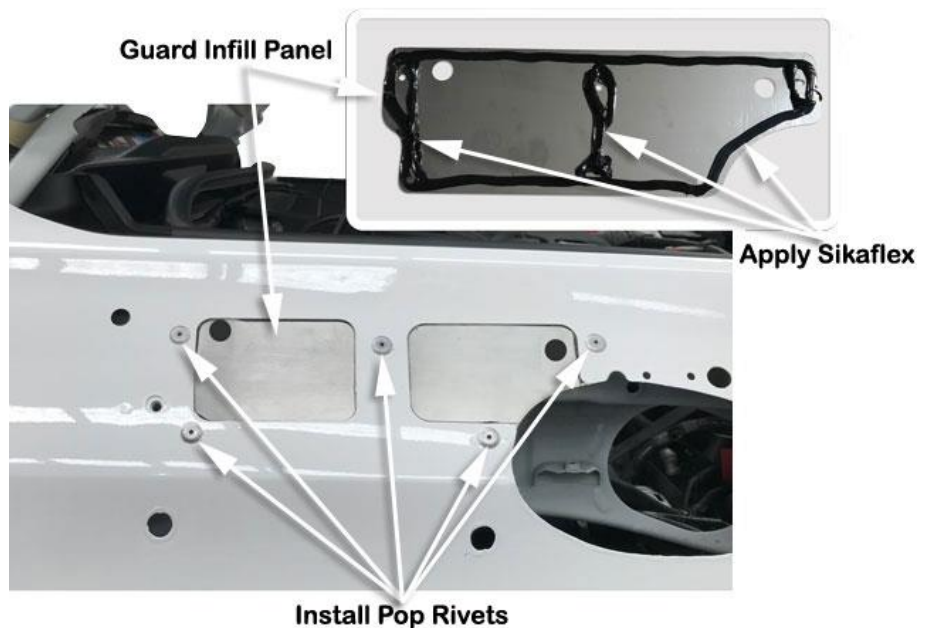

NEW ZEALAND INSTALLATIONS ONLY :

Safari have developed 2 methods of Snorkel A pillar attachment, for the conventional method please proceed with the current document alternatively please see the link below for further instructions.

www.safari4x4.co.nz/apillarmounting

13

Install the upper mounting bracket (item 3) to the snorkel body (item 1) with hex bolts (Item 4).

Apply Loctite 243 to each of the stainless steel mounting studs (item 7) and install the studs finger tight into the snorkel body (item 1) mounting inserts as shown.

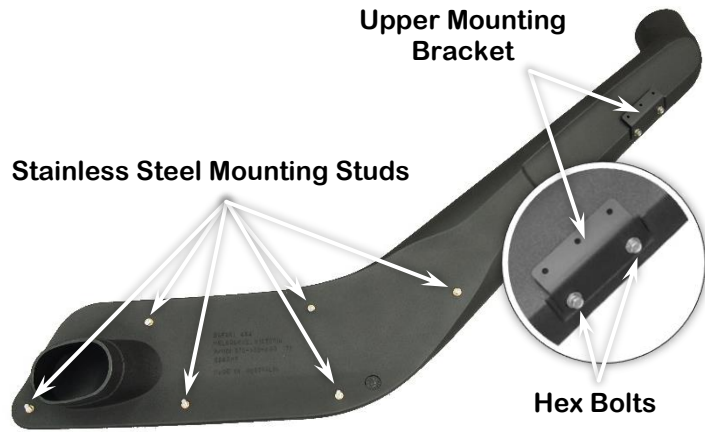

14

Remove the self-adhesive backing sheet from the foam body gasket (item 15).

Align the foam body gasket (adhesive side down) to the back of the snorkel body and press down on the foam body gasket to adhere to the snorkel body (item 1).

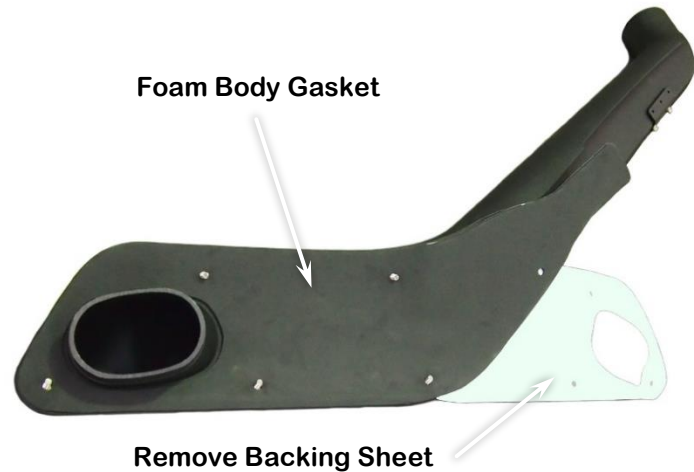

15

Place a strip of masking tape along the A-Pillar panel.

Carefully install the snorkel body (item 1) to the guard panel.

With the snorkel body correctly positioned, mark the outline of the upper mounting bracket (item 3) onto the masking tape.



Remove the snorkel body (item 1) from the vehicle, remove the upper mounting bracket (item 3) from the snorkel body.

Position the upper mounting bracket onto the A-Pillar and align the bracket with the marked bracket outline. Mark the three mounting hole positions with a felt tip pen.

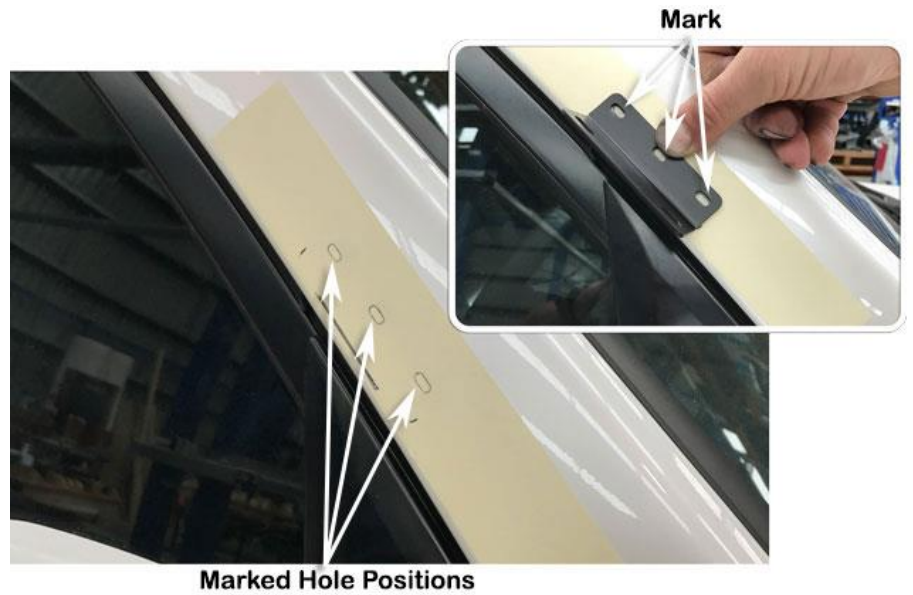

Drill a pilot hole for each of the three marked hole positions in the centre of each marked slot.

Drill each pilot hole to 8mm diameter with a step drill or 8mm drill bit.

Deburr and paint holes.

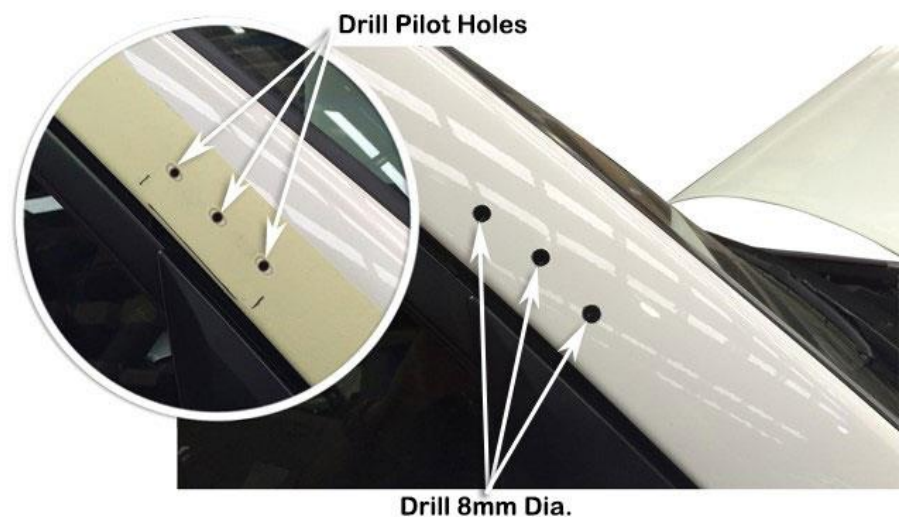

Install the plastic inserts (item 6) into the 8mm diameter holes in the A-pillar.

Secure the upper mounting bracket (item 3) to the A-pillar with three self-tapping screws (item 5).

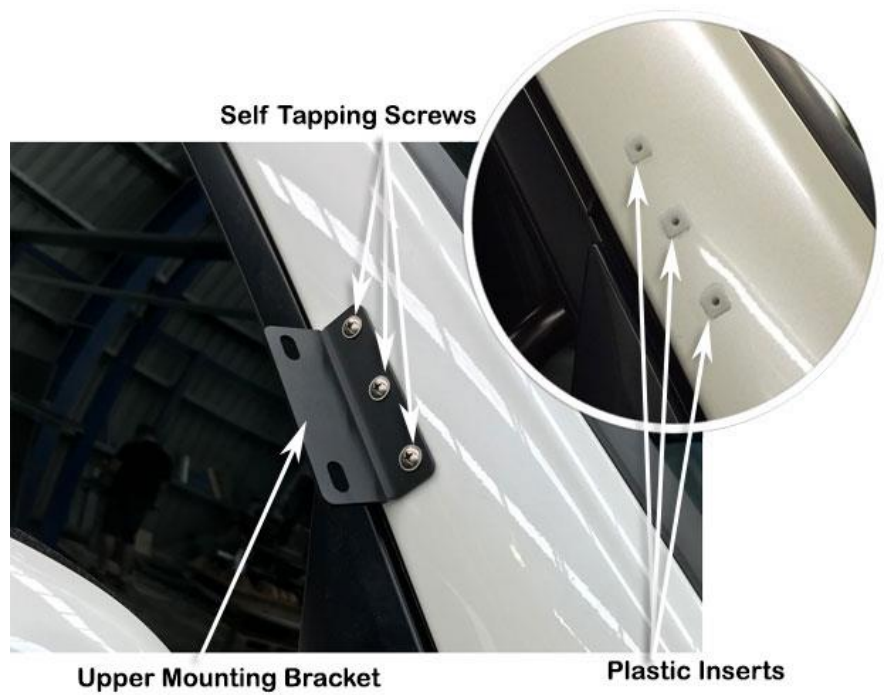

Install the A-pillar blank-off plate (item 23) and rubber gasket (Item 24) to the A-pillar, secure with the standard Toyota bolt assemblies removed in step 2.

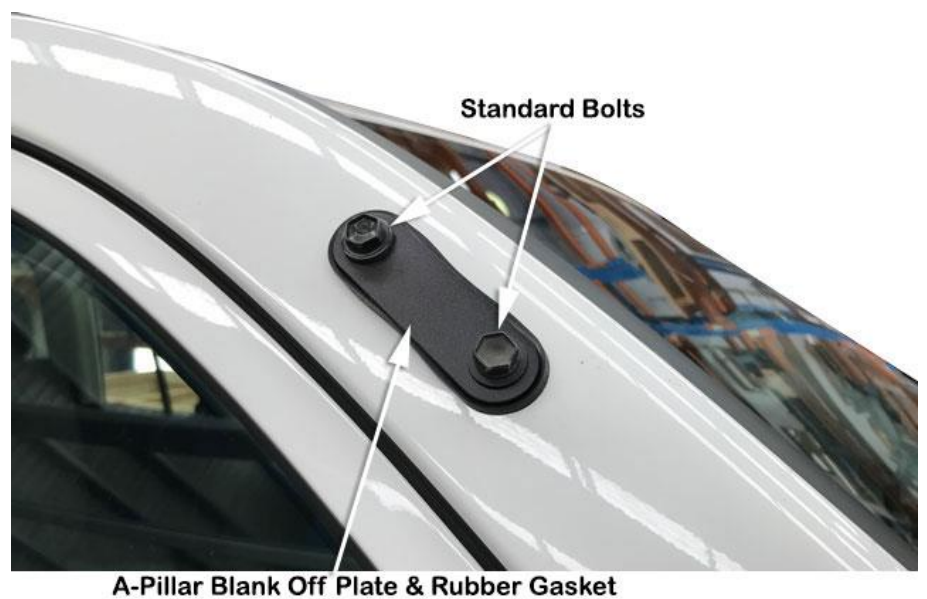

Install the plastic plug (item 22) into the rear lower factory mounting hole.

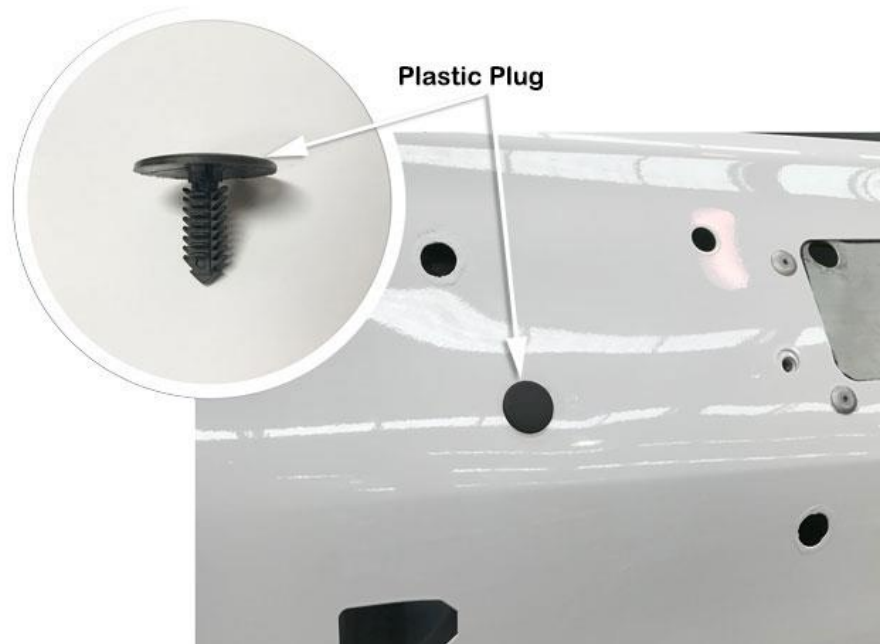

Remove and discard the foam sealing tape from the air cleaner inlet snout.

Using a small flat blade screwdriver un-clip the pre-spinner from the air cleaner inlet.

Remove the pre-spinner.



Remove the drain valve assembly from the air cleaner base.

The pre-spinner chamber must be completely removed from the air cleaner inlet, using the necessary tools carefully remove the chamber as shown.

Step 1; Using a die grinder with a cut-off disc remove as much of the internal tube as possible (46mm approximately), care must be taken when using the cut-off disc not to cut through the outer and inner walls of the air cleaner base.

Step 2; Using a die grinder with a suitable burr, carefully remove the end section of the internal tube.

Step 3; Use a file to neatly remove the remaining material from the end of the chamber.

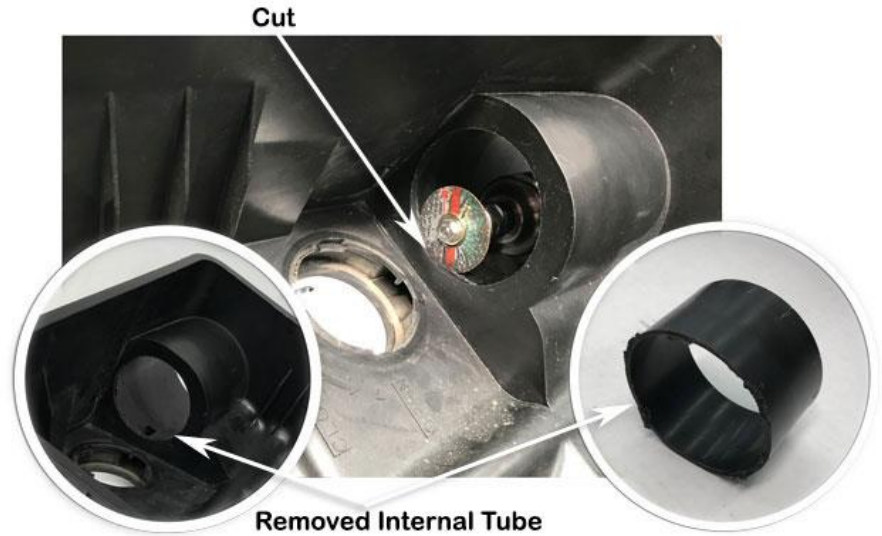

Using the body saw remove all the vanes from the pre-spinner, use a file or die grinder to remove all the remaining sections of vanes.

Apply Sikaflex adhesive sealant to the air cleaner inlet and the pre-spinner (outer sleeve), re-install the outer sleeve into the air cleaner inlet, clean-up any excess sealant.

Re-install the drain valve assembly into the air cleaner base.



Using a scribe or paint pen, scribe or mark a line 18mm in from the end of the air cleaner inlet snout around the entire circumference as shown.



INSTALLER OPTION:

The air cleaner base contains a drain valve and a drain hole as shown. These can permit water to enter the air intake.

Safari advises that the drain valve and drain hole should be sealed to ensure a watertight installation.

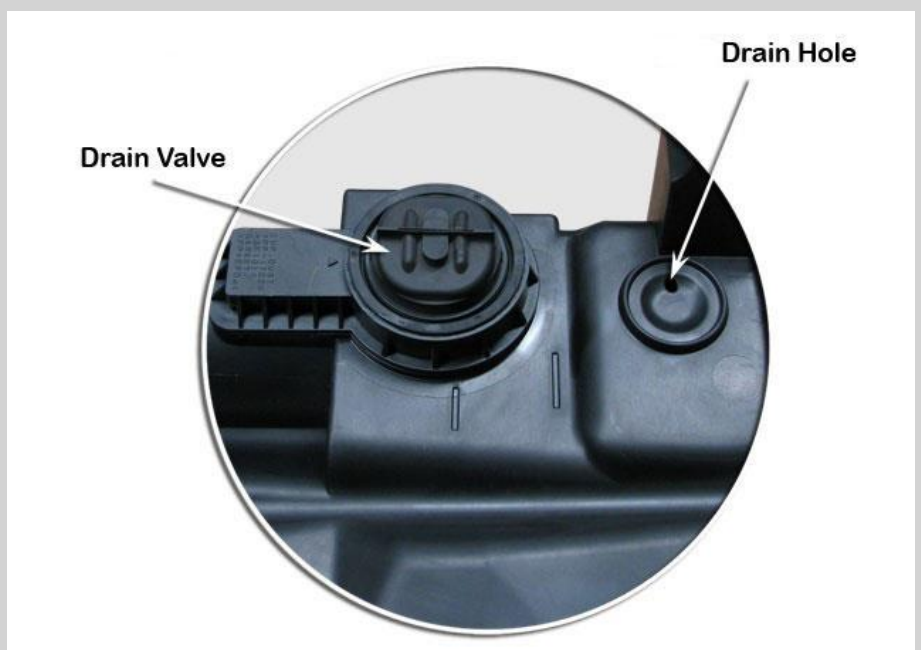

Install the air cleaner base into the vehicle. Fasten with the original mounting hardware.

Loosely install a 90/110mm hose clamp (item 12) over the air cleaner inlet.

Apply a small amount of lubricant to the round end of the air entry hose (item 11), install the hose through the hole in the inner guard panel and onto the air cleaner inlet, rotate and align the hose with the main hole in the guard panel.

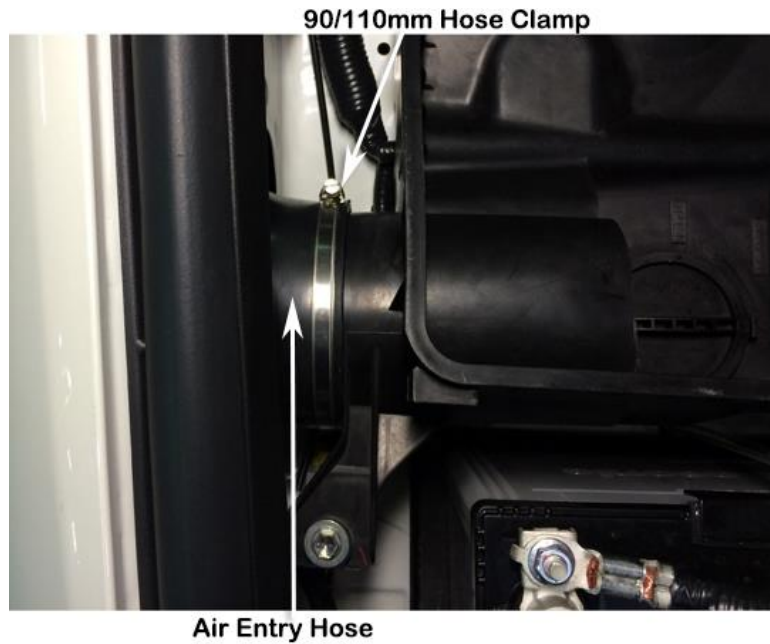

Carefully shape the 120/140mm hose clamp (item 13) to the oval shape of the air entry hose (item 11).

Note: hose clamp orientation.

Loosely install the 120/140mm hose clamp (item 13) onto the air entry hose (item 11) orientated the hose clamp onto the air entry hose as shown.

Apply a small amount of lubricant to the inside of the air entry hose.



Carefully install the snorkel body (item 1) to the guard panel, guiding the snorkel body outlet snout into the air entry hose (item 11).

Align the snorkel body to the guard panel and upper mounting bracket, fasten the snorkel body to the guard panel with rubber washers (item 8), body washers (item 9) and nyloc nuts (item 10).

Fasten the snorkel body to the upper mounting bracket with hex bolts (item 4).



Align the air entry hose (item 11) for best fitment, ensure the hose is correctly installed onto the air cleaner inlet snout, aligning the end of the air entry hose to the marked line around the air cleaner inlet snout (confirm the hose is correctly installed onto the air cleaner inlet snout using an inspection mirror), correctly position the 90/110mm hose clamp onto the air entry hose and tighten.

Correctly position and orientate the 120/140mm hose clamp onto the air entry hose and tighten (there should be a 6.0 – 8.0mm gap between the air entry hose to the snorkel body outlet shoulder).

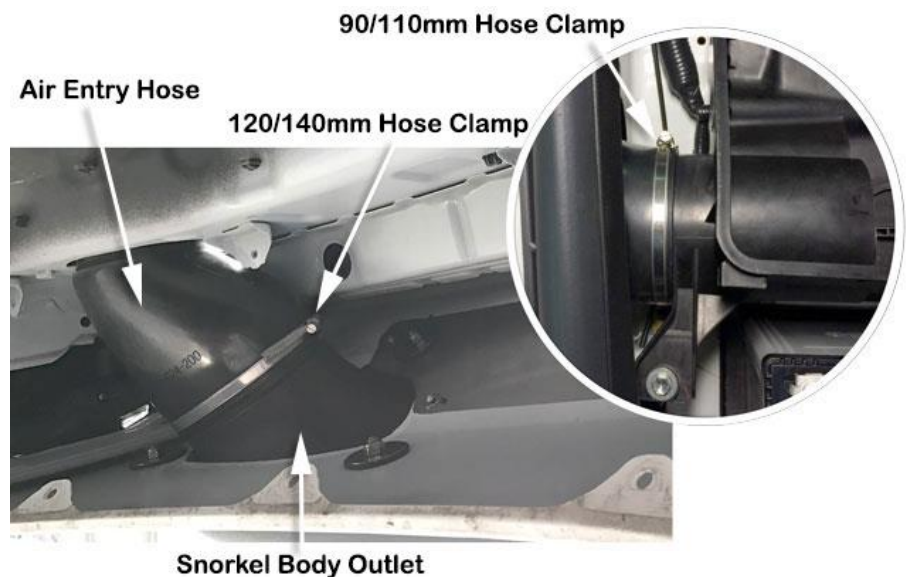

30

Loosely install the black hose clamp (item 14) to the base of the air ram assembly (item 2).

Install the air ram assembly onto the snorkel body (item 1).

Align the air ram assembly and tighten the black hose clamp (item 14).



31

Install the guard mounted indicator (if fitted to vehicle), inner guard liner, mud flap, air filter element, air cleaner lid, reconnect sensor wiring and any other items that may have been removed in accordance with the factory service manual.

32

N.B: It is the installer's responsibility to ensure that all connections are water tight.