

SS741HF

NISSAN D23 NAVARA (NP300)
2.3Ltr Intercooled Twin Turbo(YS23DDTT Engine)
Built: Nissan Motor Co. Thailand
NOTE: WIDE BODY VEHICLES ONLY



01/06/2017

Parts List

ITEM	PART NO.	DESCRIPTION	QTY
1	435-133-100	BODY - SNORKEL (SS741HF)	1
2	000-135-800	3 1/2" AIR RAM ASSEMBLY	1
3	435-032-000	BRACKET - UPPER MOUNTING	1
4	000-002-100	BOLT - HEX - 6mm x 1.0 x 14mm (SEMS)	4
5	000-951-300	SCREW - S/T - 4.2mm x 16mm - S/S	3
6	000-960	INSERT - PLASTIC	3
7	000-131	STUD - 8mm x 1.25 x 25mm - S/S (GRUB SCREW)	6
8	000-311-300	WASHER - BODY - 8mm x 30mm - S/S	6
9	000-205-300	NUT - NYLOC - 8mm x 1.25mm - S/S	6
10	435-024-200	HOSE - AIR ENTRY	1
11	435-217-000	TEMPLATE - AIR CLEANER	1
12	435-025-000	PLATE - CLAMPING (upper)	1
13	435-025-100	PLATE - CLAMPING (side RH)	1
14	435-025-200	PLATE - CLAMPING (side LH)	1
15	435-025-300	PLATE - CLAMPING (lower)	1
16	000-958-175	POP RIVET - 4mm x 17mm	10
17	000-958-750	POP RIVET - 4mm x 20mm (Splade)	4

18	000-300-350	WASHER - BODY 4mm x 12mm S/S	7
19	435-959-000	CAP - AIR INLET BLANK-OFF	1
20	000-906	CLAMP - HOSE - 50/70mm - S/S	1
21	000-908	CLAMP - HOSE - 70/90mm - S/S	1
22	435-089-000	BRACKET - ECU RELOCATION	1
23	435-089-100	BRACKET - ECU SUPPORT	1
24	435-089-200	BRACKET – IDLE CONTROL MODULE RELOCATION	1
25	435-089-300	BRACKET - BASE SUPPORT	1
26	000-002	BOLT - HEX - 6.0mm x 1.0mm x 16mm - (Zinc)	3
27	000-003	BOLT - HEX - 6.0mm x 1.0mm x 20mm - (Zinc)	3
28	000-004	BOLT - HEX - 6.0mm x 1.0mm x 25mm - (Zinc)	4
29	000-310-100	WASHER - BODY 6.0mm x 15mm - (Zinc)	23
30	000-204	NUT - NYLOC - 6.0mm x 1.0mm - S/S	7
31	000-322	WASHER - BODY - 6.0mm x 30mm - S/S	2
32	000-1022-300	BOLT - B/H CAP SCREW - 5.0mm x 0.8 x 16mm - S/S	1
33	000-320-350	WASHER - BODY - 5.0mm x 15mm - S/S	2
34	000-221-300	NUT -NYLOC - 5.0mm x 0.8mm - S/S	1
35	000-958-300	POP RIVET - 4.8mm x 12mm	1
36	000-914/B	CLAMP - HOSE SIZE 56 (BLACK)	1
37	435-017-300	TEMPLATE - INNER GUARD	1
38	435-017-100	TEMPLATE - GUARD PANEL	1



4X4 ENGINEERING

SS741HF

NISSAN D23 NAVARA (NP300)
2.3Ltr Intercooled Twin Turbo(YS23DDTT Engine)

Built: Nissan Motor Co. Thailand

NOTE: WIDE BODY VEHICLES ONLY

Installation Guide

Fitment to:

- Right Hand Side

Fitting Time:

- 180min

Special Tools:

- Body Saw (reciprocating)
- Step drill
- Masking Tape
- Grinder / Files
- Pop Rivet Gun
- Loctite 243 (thread lock)
- Touch-up paint
- Sikaflex 227 Adhesive Sealant

Prior to commencing the installation, it is the installer's responsibility to verify that all components and particularly the template (Item 37 & 38) are correct.

1

Disconnect the negative battery terminal.

Remove the following in accordance with the factory service manual:

- RHS mud flap
- RHS Inner guard liner
- Air cleaner assembly
- Washer Bottle Assembly
- ECU & Idle Control Module
- Air Cleaner Mounting Bracket
- Relay box and Mounting Bracket
- Earth strap

2

Remove and discard

- Air intake Duct & rubber seal
- ECU Mounting Bracket
- Idle Control Module Mounting Bracket

Remove & Discard



3

Remove and discard the perforated section from the guard panel template (item 38) as shown.

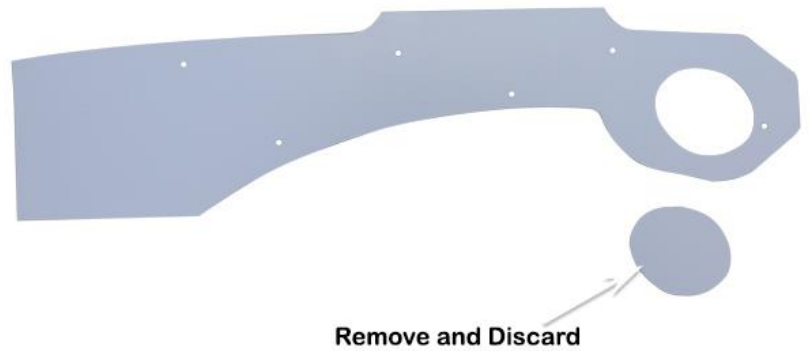

4

Align the guard panel template (item 38) to the upper and rear edges of the right hand guard panel as shown.

Tape the template to the guard with masking tape.

Mark all hole position and the snorkel body outlet hole with a felt tip pen.

Remove the template.

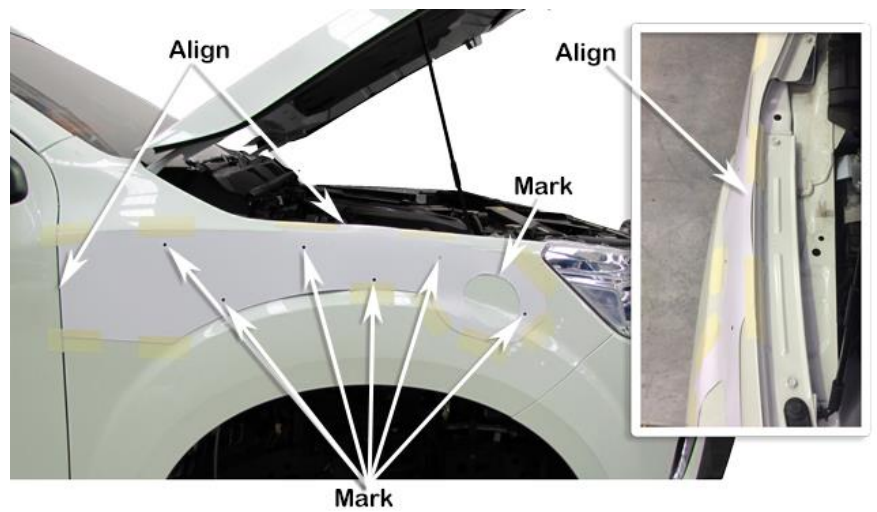

5

Drill a pilot hole for each marked hole position.

Use a step drill to drill the six mounting hole positions to 16mm diameter.

Using the body saw, cut the snorkel body outlet hole in the guard panel.

Deburr and paint holes to prevent rust.

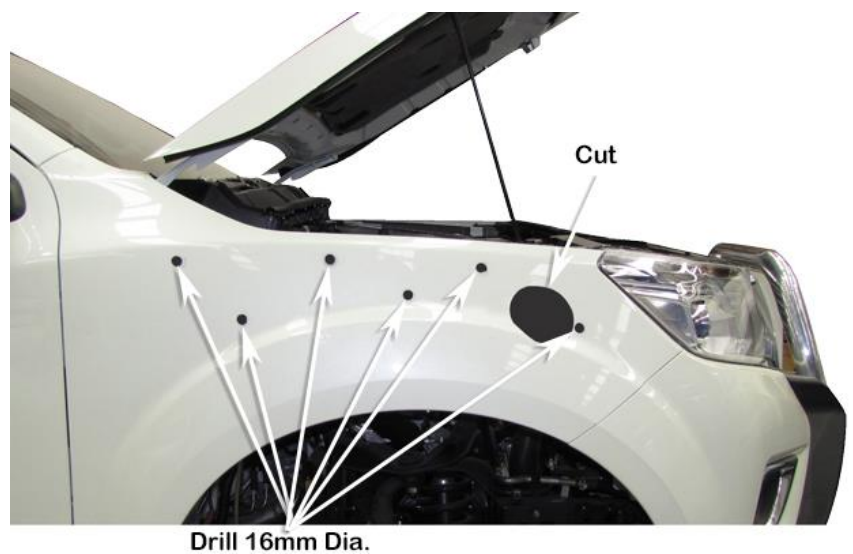

NEW ZEALAND INSTALLATIONS ONLY :

Safari have developed 2 methods of Snorkel A pillar attachment, for the conventional method please proceed with the current document alternatively please see the link below for further instructions.

www.safari4x4.co.nz/apillarmounting

6

Install the upper mounting bracket (item 3) to the snorkel body (item 1) with hex bolts (item 4).

Apply Loctite 243 to each of the stainless steel mounting studs (Item 7), using a 4mm Allen key install the studs finger tight into the snorkel body (item 1) mounting inserts.

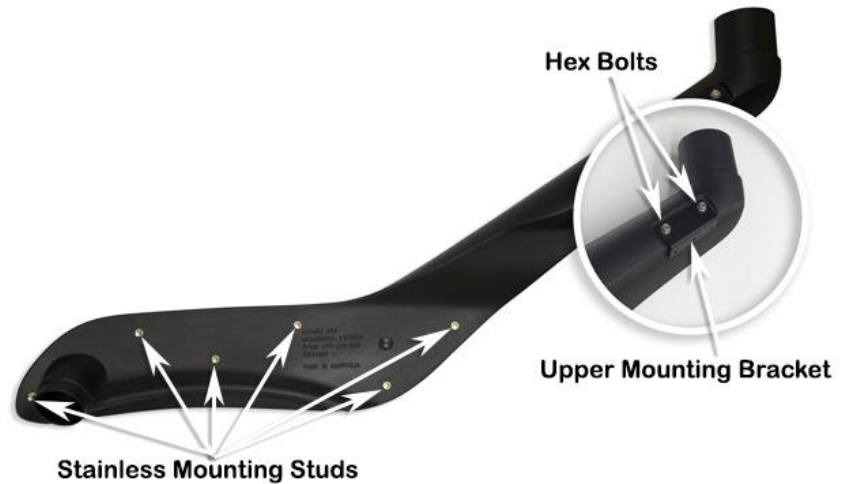

7

Place a strip of masking tape along the A-Pillar panel.

Carefully install the snorkel body (Item 1) to the guard panel.

With the snorkel body correctly positioned, mark the outline of the upper mounting bracket (Item 3) onto the masking tape.



8

Remove the snorkel body (Item 1) from the vehicle and remove the upper mounting bracket (Item 3) from the snorkel body.

Position the upper mounting bracket onto the A-Pillar and align the bracket with the marked bracket outline.

Mark the three mounting hole positions with a felt tip pen.

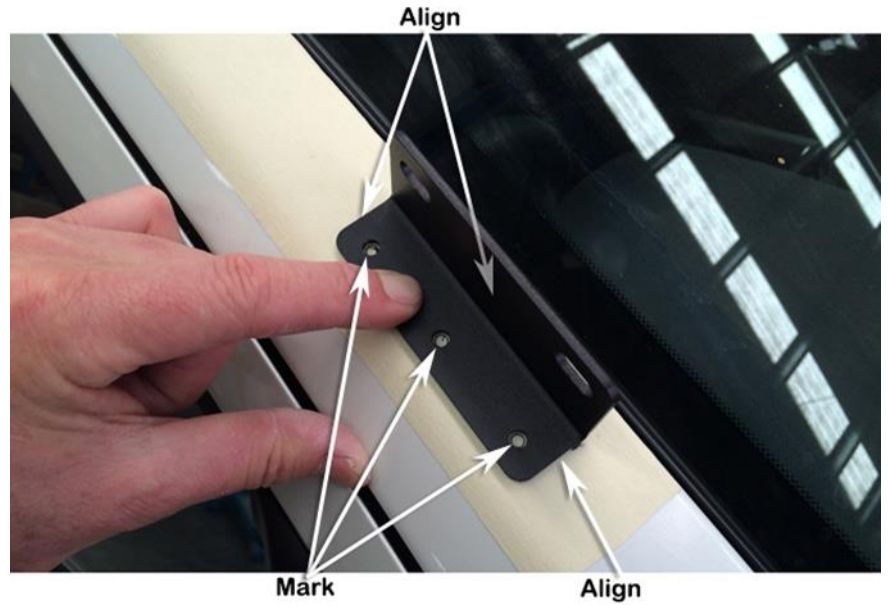

9

Drill a pilot hole at each of the three marked hole positions. Drill each hole position to 8mm diameter with a step drill or 8mm drill bit.

Deburr and paint holes to prevent rust.

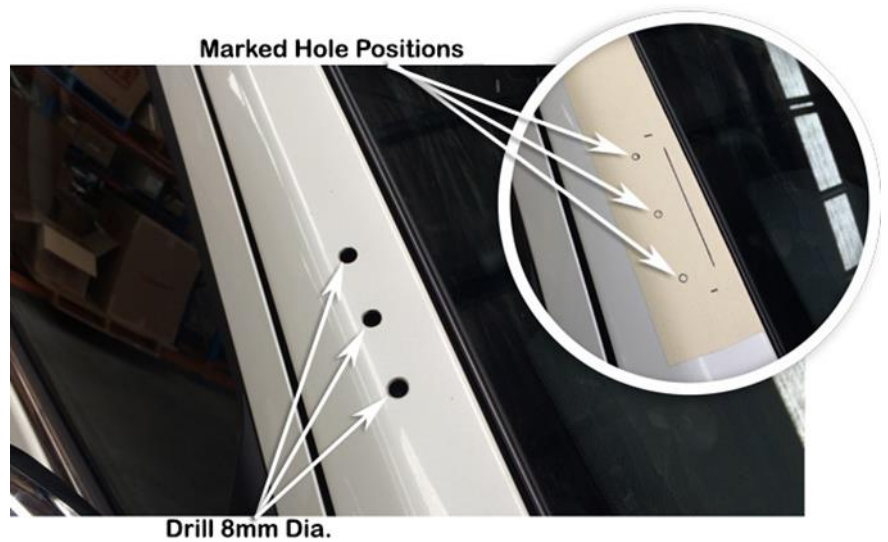

Install the plastic inserts (Item 6) into the 8mm diameter holes in the A-pillar.

Secure the upper mounting bracket (Item 3) to the A-pillar with three stainless steel self-tapping screws (Item 5).

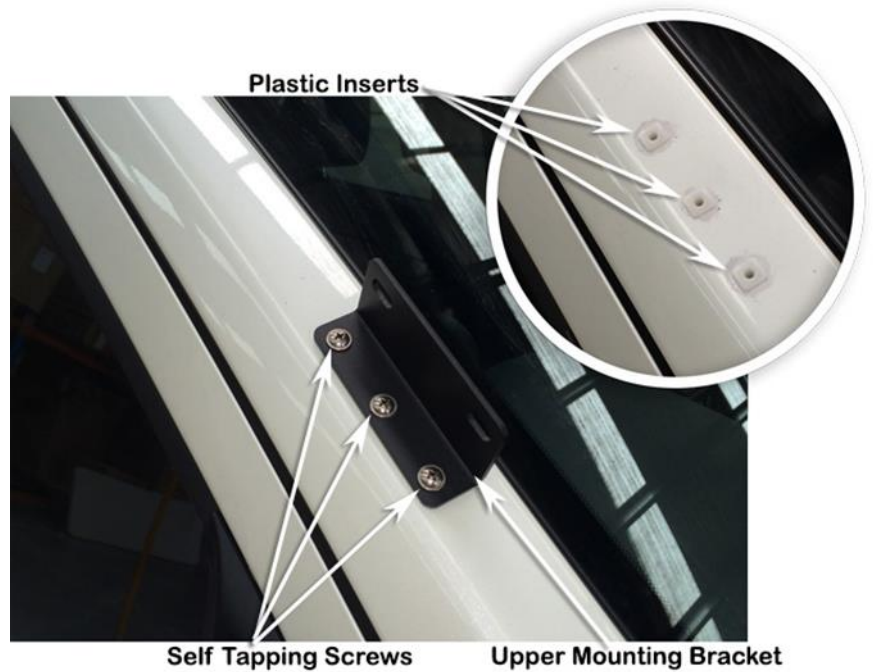

Align the inner guard template onto the lower left hand stud and the two M6 captive nuts as shown.

Attach the template using two 6mm bolts.

Using a felt tip pen, mark the inner guard cut-out onto the inner guard panel and the inner guard hole position as shown.

Remove the template.

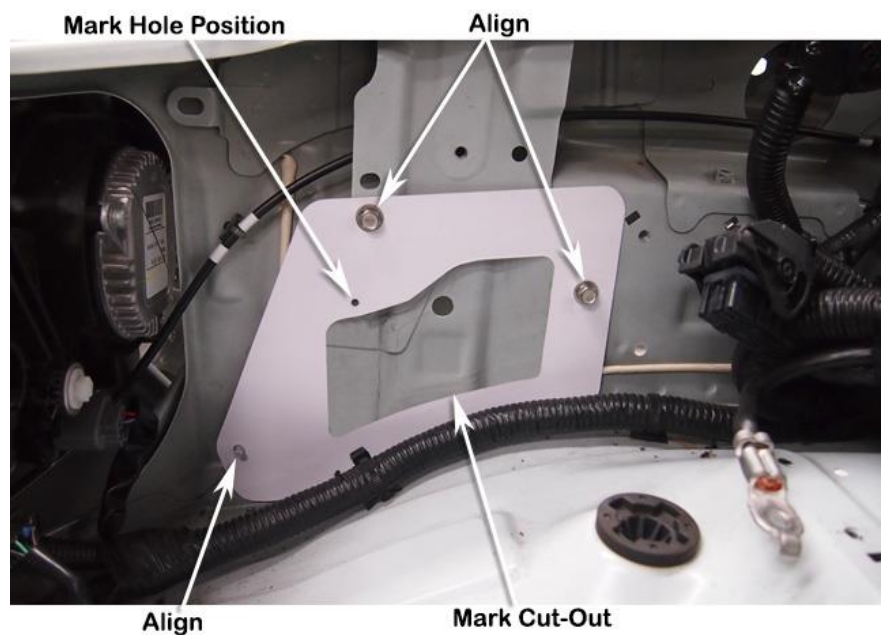

12

Using the body saw, cut the hole in the inner guard panel as shown.

Drill a pilot hole for the marked hole position, drill the hole to 5.5mm diameter in the inner guard panel.

Deburr and paint the holes to prevent rust.

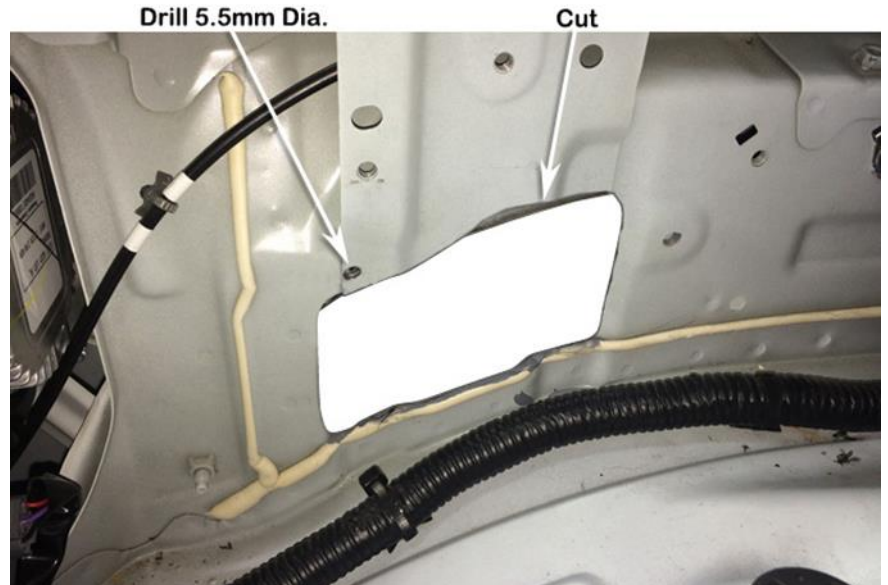

13

Install a 5.0mm body washer (item 27) onto the 5.0mm x 16mm button head cap screw (item 26), install the bolt with washer installed through the 5.5mm hole drilled in the inner guard panel, install a 5.0mm body washers (item 27) and a 5.0mm Nyloc nut (item 28), tighten the nyloc nut securing the panels together.

5mm B/H Bolt & Body Washer



Body Washer & 5mm Nyloc Nut

Measure and mark a line approximately 60mm down from the underside of the air cleaner mounting bracket.

Using a body saw, cut-off the lower section of the bracket as shown.

Measure and mark a hole position approximately 35mm down from the underside of the of the air cleaner mounting bracket as shown.

Drill the marked hole position to 5.0mm diameter.

Deburr and paint the hole and cut edge of the bracket to prevent rust.

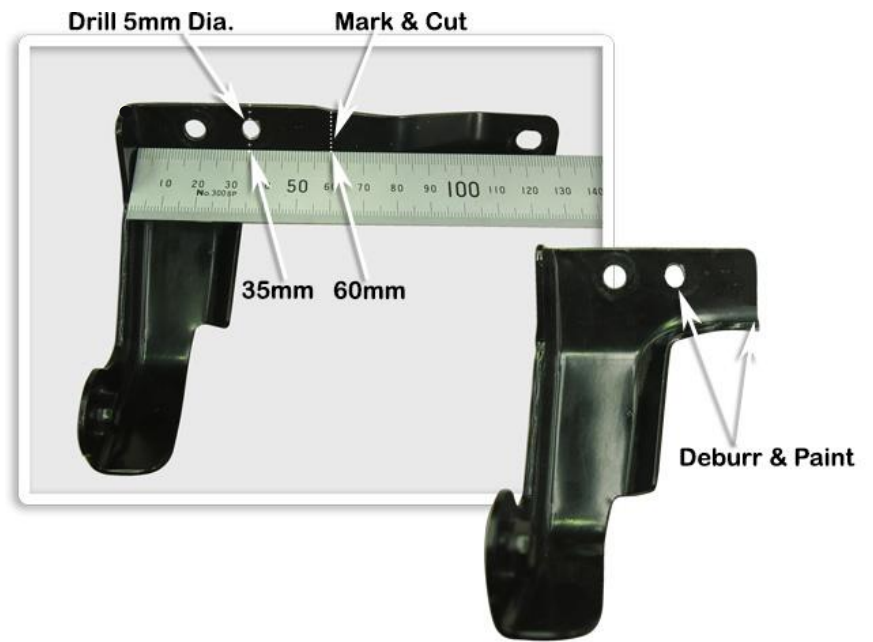

Install the air cleaner mounting bracket, fasten to the inner guard support bracket using the standard mounting bolt.

Using a 5.0mm drill bit, drill the new lower mounting hole through the air cleaner mounting bracket and inner guard support bracket.

Deburr and paint the 5.0mm hole.

Install a 4.8 x 12mm pop rivet (item 35) through the bracket and inner guard support bracket, using the pop rivet gun secure the pop rivet.

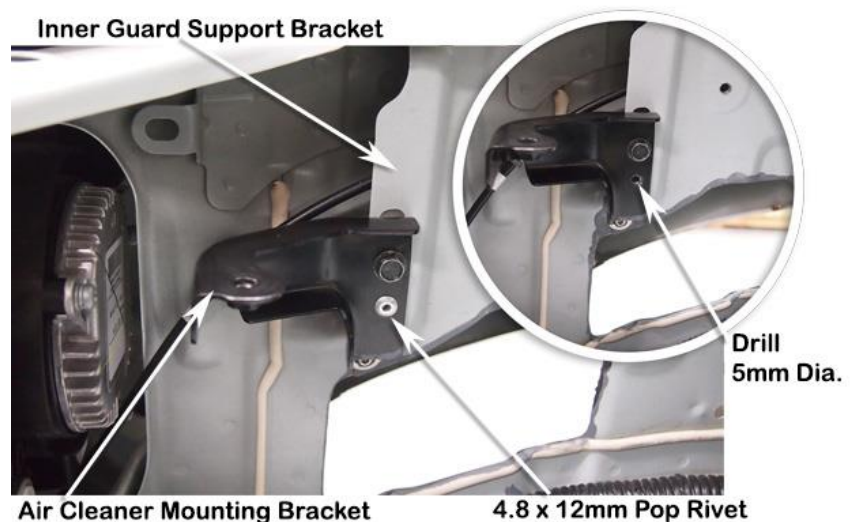

Assemble the ECU module to ECU relocation bracket (item 22) with four 6.0mm x 25mm hex bolts (item 28) and 6.0mm body washers (item 29), install the bolts with washers installed through the bracket and ECU. Install the four standard ECU flange nuts and tighten the four nuts.

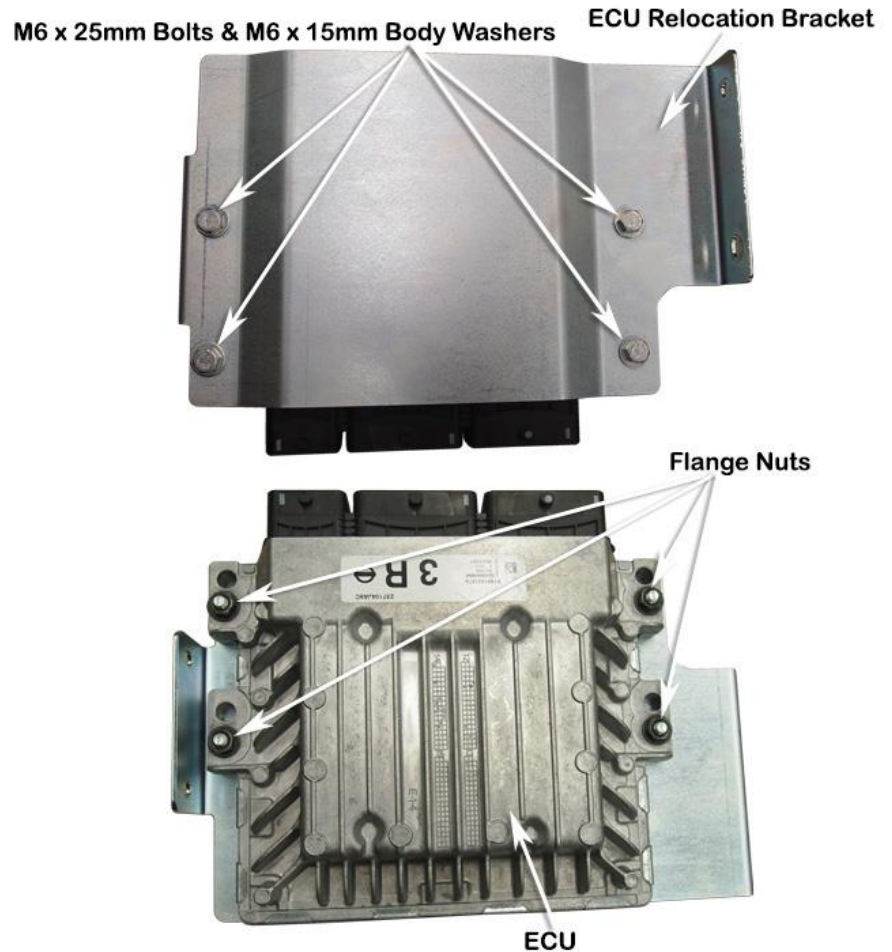

Assemble the idle control module to the relocation bracket (item 24) with three 6.0mm x 20mm hex bolts, (item 27) and three 6.0mm body washers (item 29), install the bolts with washers installed through the bracket, install two 6.0mm body washers to each of the bolts for spacers, and install the idle control module. Install a 6.0mm body washer and a 6.0mm nyloc nut (item 30) to each of the bolts.

With the idle control module correctly orientated on the bracket tighten the 6.0mm nyloc nuts (item 30).

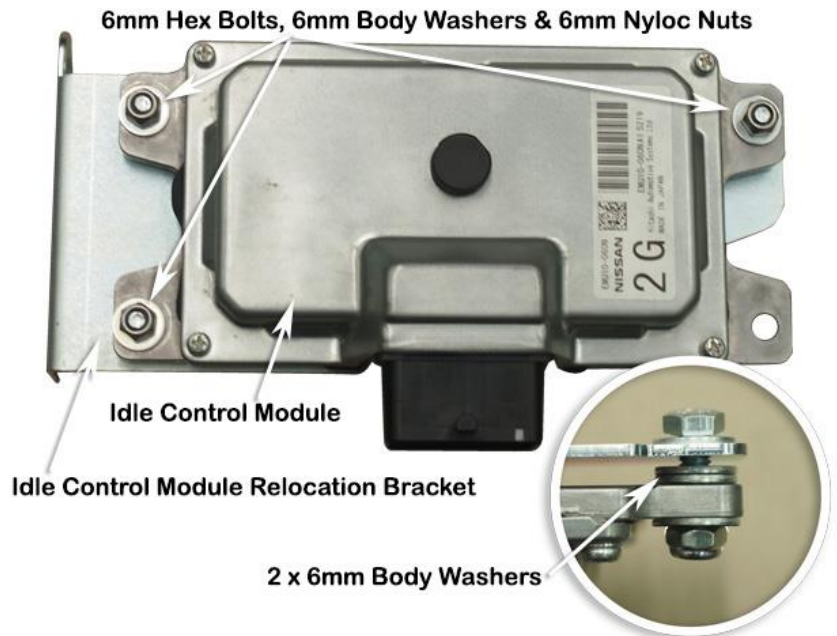

Remove the module from the inner guard panel shown, retain 6mm hex bolt.

Install the ECU support bracket (item 23) to the inner guard panel, loosely Re-fit the module and ECU support bracket to the inner guard panel using the standard 6mm hex bolt.

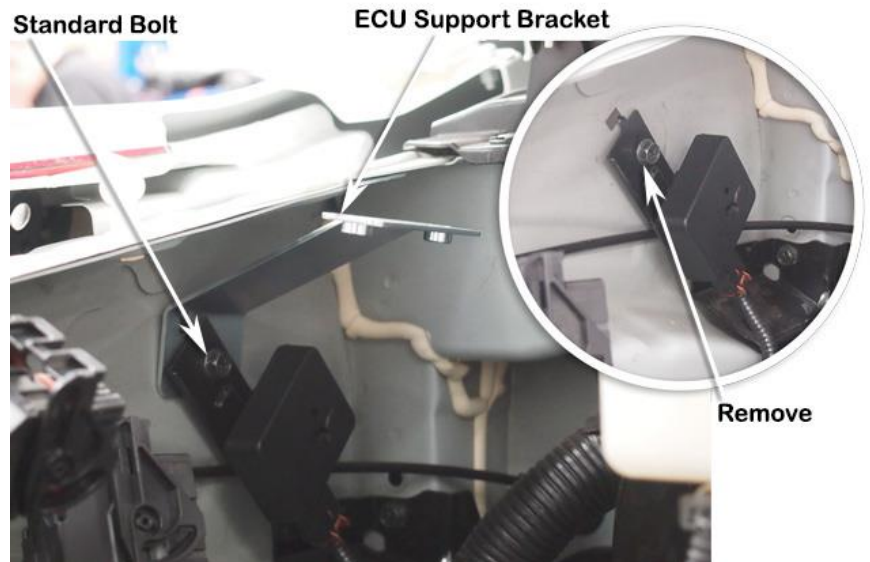

Install the ECU control module and bracket to the vehicle using the two standard 6mm hex bolts previously removed in step one.

Secure the top of the ECU relocation bracket to ECU support bracket (item 23) with two 6mm x 14mm SEMS bolts (item 4)

Tighten the standard bolts securing the control module bracket and support bracket.

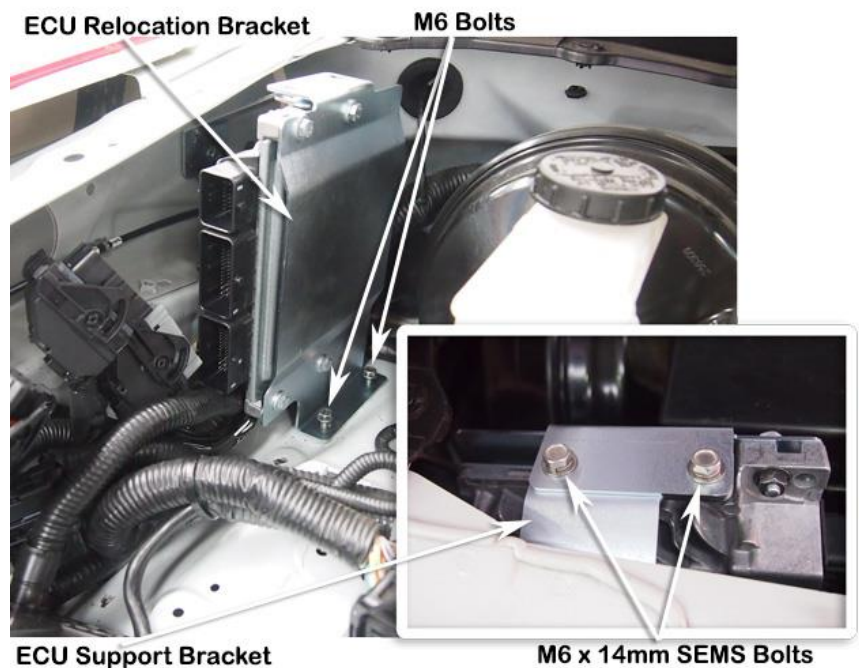

Install two 6mm x 30mm body washers (item 31) to the studs in front of the brake booster.

Fit the base support bracket (item 25) over the two studs. Align all of the holes in the base support bracket to the holes in the wheel arch panel, secure the bracket with 6mm body washer (item 29) and 6mm nyloc nut (item 30).

Install the relay box mounting bracket to the two mounting studs on the base support bracket, secure the bracket with the two 6mm flange nuts removed in step 1.

Re-fit the relay box to the relay box bracket. Secure the relay box to the bracket using the standard 6mm bolt removed from the bracket in step 1.

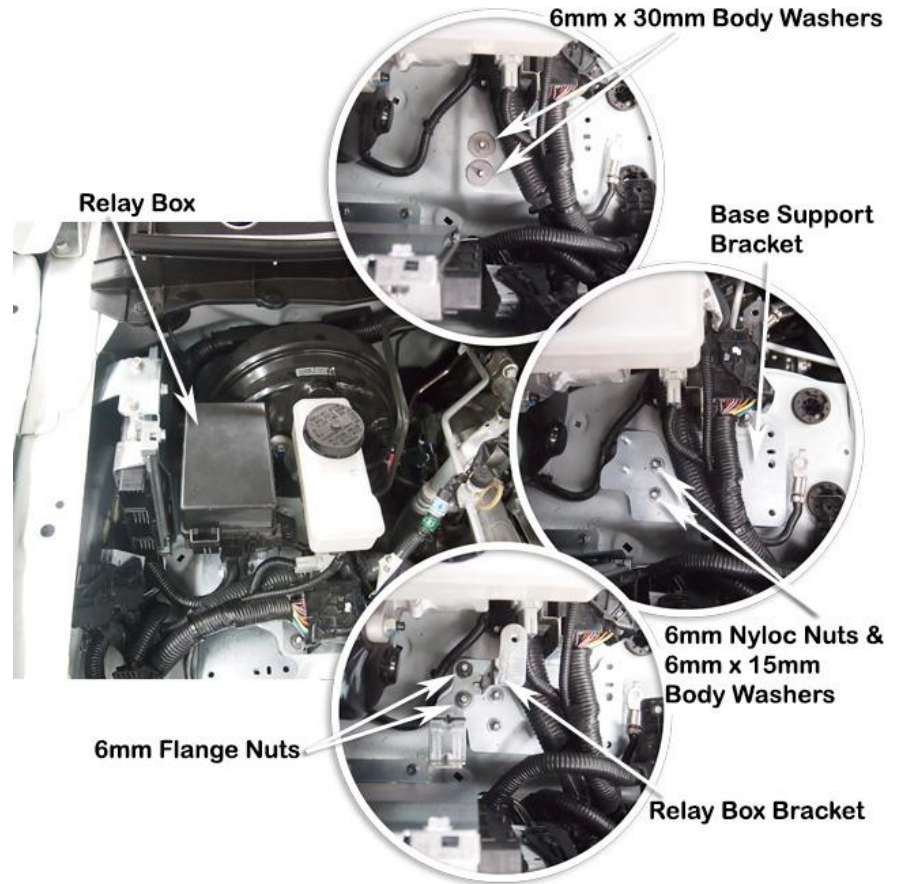

Re-connect the three ECU wiring plugs to the ECU module.

Install the idle control module to the base support bracket, secure with 6mm x 16mm hex bolts (item 26) and 6mm body washers (item 29), install 6mm body washers (item 29) and 6mm nyloc nuts (item 30). Tighten the nyloc nuts.

Install the earth strap to the base support bracket, secure with a 6mm x 16mm hex bolt (item 26) and 6mm washer. (item 29)

Re-connect the wiring plug to the idle control module.



Remove and discard the air tube from the air cleaner base.

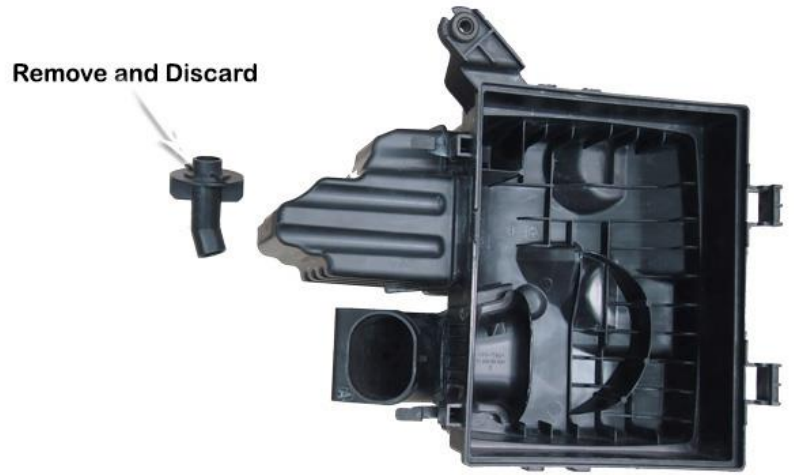

Align the air cleaner template to the air cleaner base.

Mark the two hole positions and the cut-out section onto the air cleaner base.



Using a body saw, remove the marked cut-out section of the air cleaner base.

Drill the marked hole positions to 4.5mm diameter.

Mark a line 25mm down from the underside edge of the air cleaner base

Using a grinder, remove the ribs from the outside of the air cleaner base below the marked line as shown.

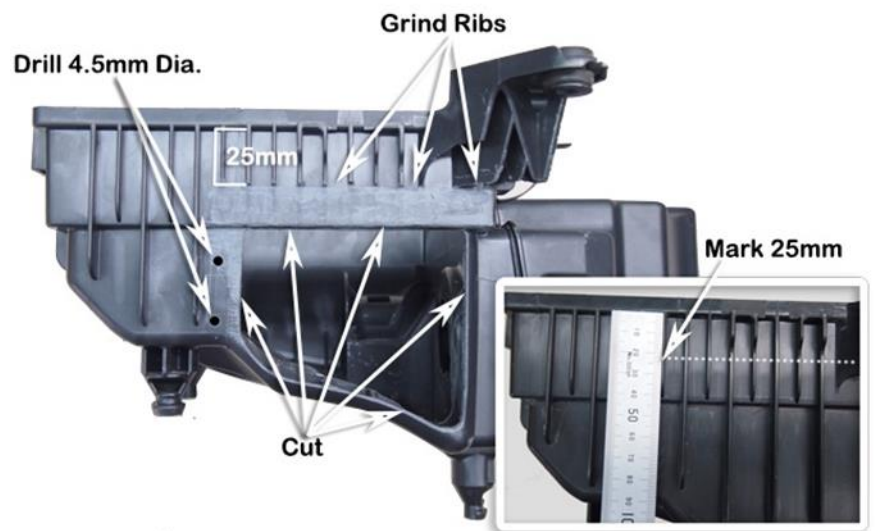

Using a body saw or die grinder remove the ribs as shown.

Using the body saw and die grinder, remove the panels as shown from the front right hand corner of the air cleaner base.

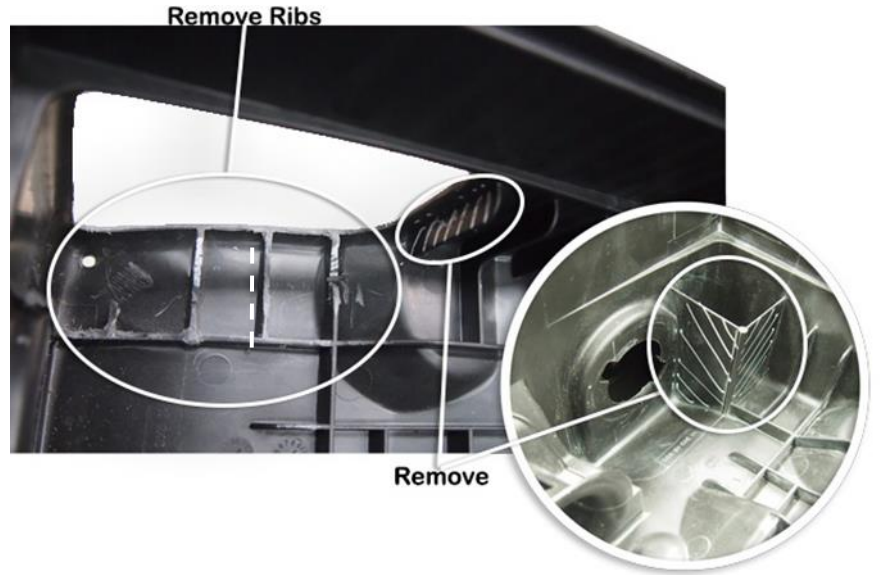

Mask along the edge of the air cleaner base.

Fit the air entry hose up to the air cleaner base and locate with two rivets through the 4.5mm holes drilled previously.

Mark the location of the remaining twelve holes using the air entry hose (item 10) as a template.

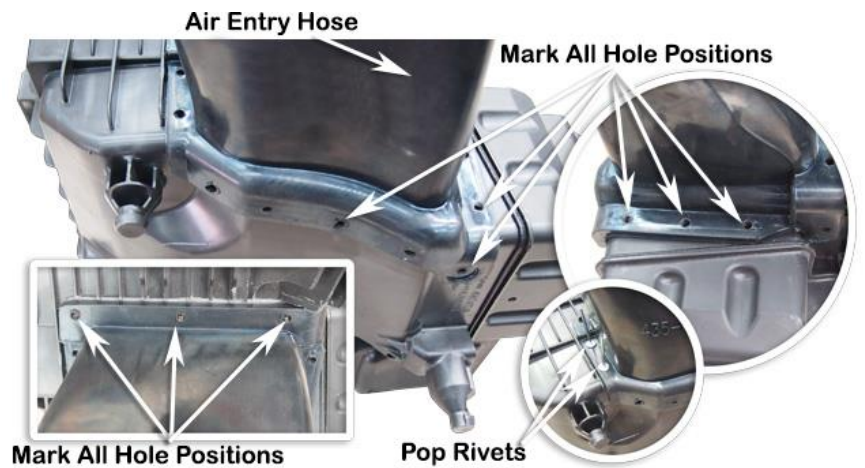

Remove the hose and drill the twelve marked hole positions with a 4.5mm drill bit.

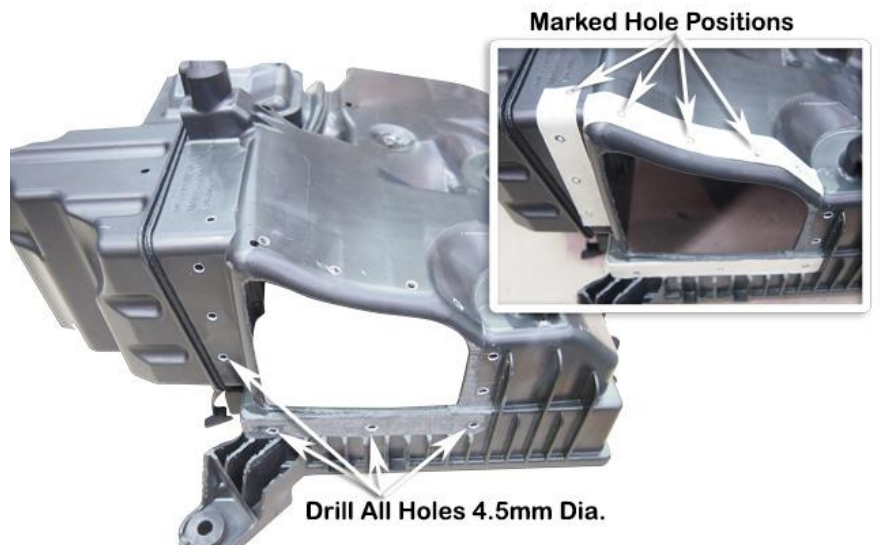

Apply sealant to the flange of the air entry hose.

Position the air entry hose onto the air cleaner base.

From the inside of the air cleaner base install six 4mm x 17mm pop rivets (item 16), install the top and LH side clamp plates (items 12 and 14), install a 4mm body washer (item 18) on the top right hand corner.

From the underside of the air cleaner base install the lower clamp plate (item 15) and install three 4mm x 17mm pop rivets (item 16), install a 4mm body washer (item 18) to a 4mm x 17mm pop rivet item (16) and install the pop rivet through the air entry hose. Install a 4mm body washers (item 18) over the four rivets on the inside of the air cleaner base.

Install the RH side clamp plate with three 4mm x 20mm splade pop rivets (item 17), install a 4mm body washer to the 4mm x 20mm splade pop rivet and install the rivet (item 17).

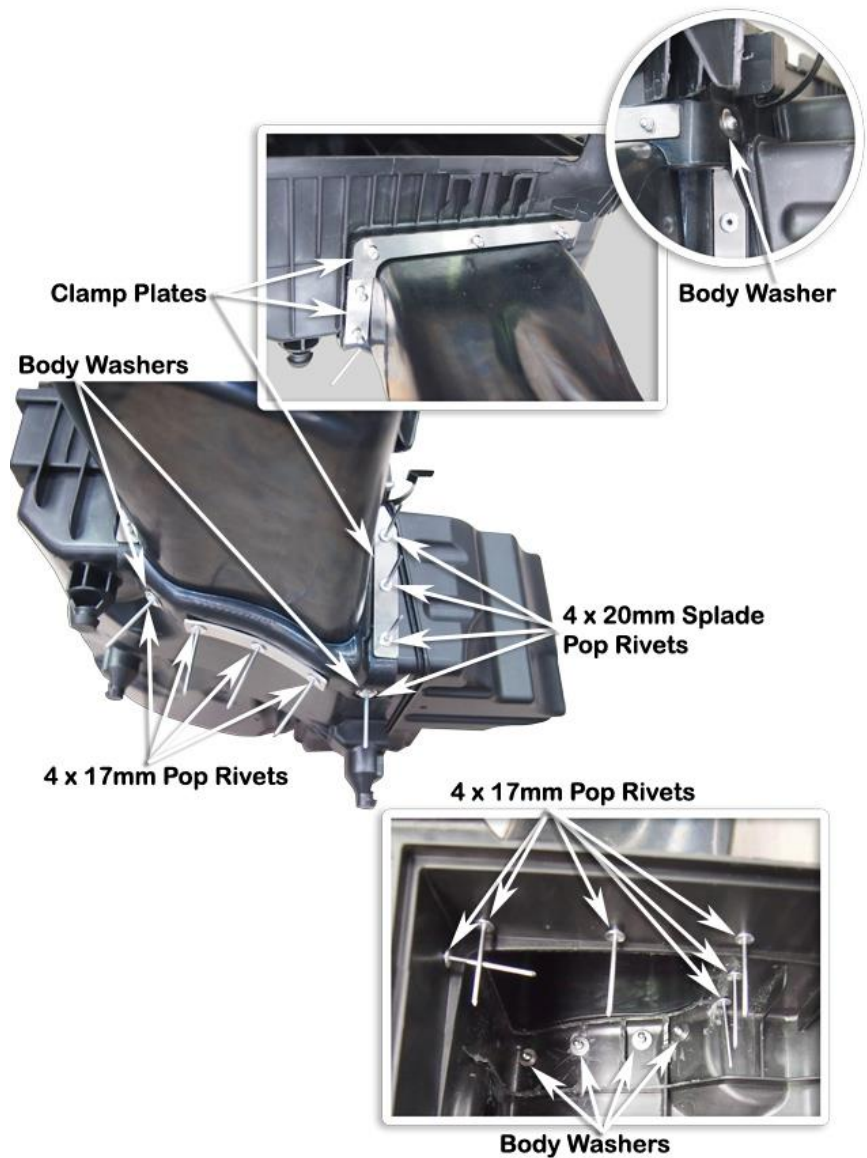

With all pop rivets, clamp plates and body washers in place, secure all pop rivets using a pop rivet gun. Clean-up any excess sealant to ensure a neat finish.

30

Install the air inlet blank-off cap (item 19) over the standard air intake hole, install a 50/70mm hose clamp and tighten the hose clamp.

Note the orientation of the hose clamp.



31

INSTALLER OPTION :

The air cleaner housing base contains four drain holes as shown. The drain holes can permit water to enter the air intake.

Safari advises that the drain holes should be sealed to ensure a watertight installation.



32 Install the air cleaner base and hose assembly into the vehicle. *Hint: squash the end of the hose whilst installing through the hole in the inner guard.*

Correctly install the air cleaner base into the three rubber mounting grommets and secure with the standard mounting bolt.

Loosely install the 70/90mm hose clamp (item 21) over the air intake hose and position as shown.

Note the orientation of the hose clamp.

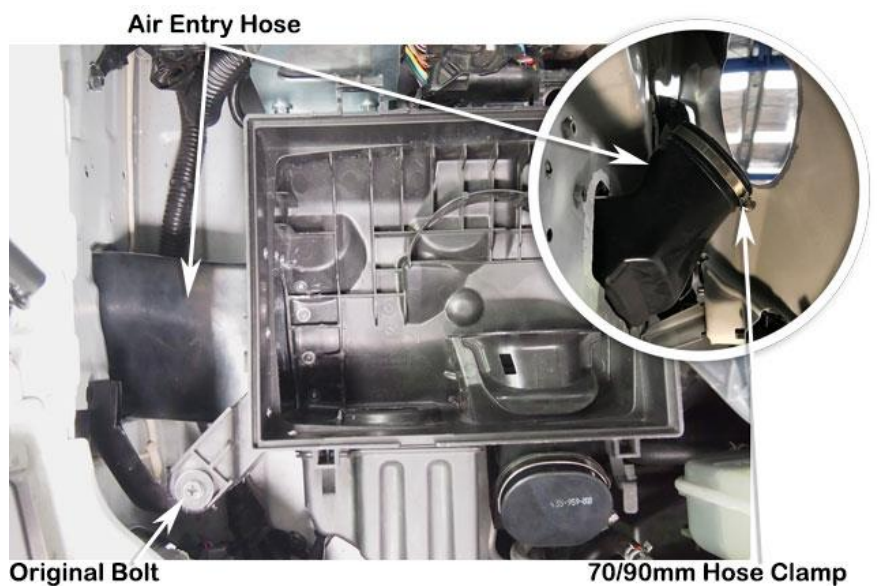

Apply a small amount of CRC lubricant to the air entry hose (item 10).

Carefully install the snorkel body (item 1) to the guard panel, guiding the snorkel body outlet snout into the air entry hose (item 10), align the snorkel body to the guard panel and upper mounting bracket.

When correctly aligned, fasten the snorkel body to the guard panel with body washers (item 8) and nyloc nuts (item 9).

Fasten the snorkel body to the upper mounting bracket with hex bolts (item 4).

Ensure the air entry hose (item 10) is correctly installed onto the snorkel body outlet snout and tighten the 70/90mm hose clamp (item 21).

Note the orientation of the hose clamp.



Apply a small amount grease to the washer bottle mount and mounting bracket.

Install the washer bottle assembly ensuring it locates correctly into the mount.

Re-connect the two wiring plugs and the windscreen washer hose.

Re-install the filler neck and install the clip.

Refill washer bottle with washer fluid.

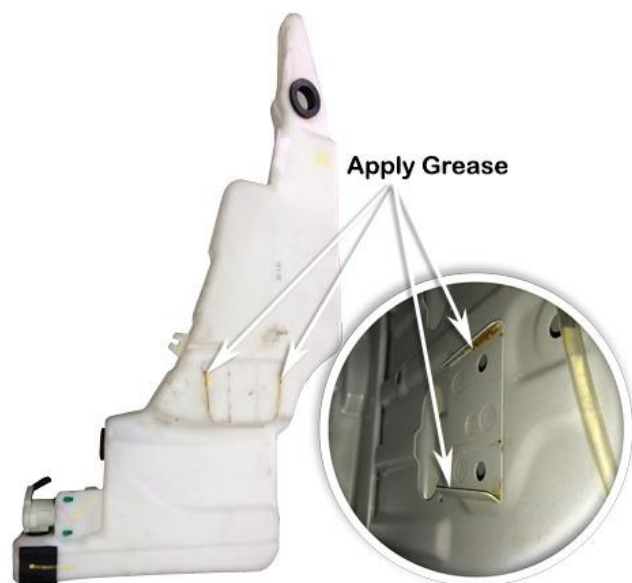

35

Install the black hose clamp (item 36) loosely over the base of the air ram assembly (item 2). Install the air ram assembly onto the snorkel body.

Align the air ram assembly and tighten the black hose clamp (item 36).



36

Reinstall the inner guard liner, mud flap, air cleaner element, air cleaner lid, reconnect mass sensor wiring plug, reconnect the negative battery terminal and any other items that may have been removed during the snorkel installation process. Road test vehicle.

37

N.B: It is the installer's responsibility to ensure that all connections are water tight.