



**4X4 ENGINEERING**

# SS730HFB

SAFARI V-SPEC SNORKEL  
NISSAN D40 NAVARA DUAL CAB / R51 PATHFINDER  
2.5L Diesel (YD25DDTi ENGINE)  
Built: NISSAN MOTOR IBERICA, S.A.  
Built Date: 04/2005 – 2009



01/10/2017

## Parts List

ITEM	PART NO.	DESCRIPTION	QTY
1	430-133-000	BODY - SNORKEL (SS730HF)	1
2	000-135-800	3 ½" AIR RAM ASSEMBLY	1
3	430-032-000	BRACKET - UPPER MOUNTING	1
4	000-002-100	BOLT - HEX - 6mm x 1.0 x 14mm (SEMS)	3
5	000-951-300	SCREW - S/T - 4.2mm x 16mm - S/S	4
6	000-960	INSERT - PLASTIC	3
7	000-110	STUD - 8mm x 1.25 x 25mm - S/S	4
8	000-311-300	WASHER - BODY - 8mm x 30mm - S/S	4
9	000-205-300	NUT - NYLOC - 8mm x 1.25mm - S/S	4
10	430-024-600	HOSE - AIR ENTRY	1
11	430-025-600	PLATE - HOSE SUPPORT	1
12	430-217-000	TEMPLATE – AIR INLET DUCT	1
13	000-958-200	POP RIVET - 4mm x 16mm	9
14	000-300-350	WASHER - BODY 4mm x 12mm	1
15	000-909	CLAMP - HOSE - 80/100mm	1
16	000-914/B	CLAMP - HOSE SIZE 56 (BLACK)	1
17	430-016-000	GASKET - FOAM BODY (SELF ADHESIVE)	1
18	430-017-000	TEMPLATE - GUARD PANEL	1



**4X4 ENGINEERING**

# SS730HFB

SAFARI V-SPEC SNORKEL  
NISSAN D40 NAVARA DUAL CAB / R51 PATHFINDER  
2.5L Diesel (YD25DDTi ENGINE)  
Built: NISSAN MOTOR IBERICA, S.A.  
Built Date: 04/2005 – 2009

## Installation Guide

### Fitment to:

- Left Hand Side

### Fitting Time:

- 150min

### Special Tools:

- 105mm hole saw
- Pop Rivet Gun
- Step drill
- Masking Tape
- 4.5mm Drill Bit
- Loctite 243 (thread lock)
- Touch-up paint
- Prep-wash
- Sikaflex 227 Adhesive Sealant

**Prior to commencing the installation, it is the installer's responsibility to verify that all components and particularly the template (Item 18) are correct.**

**1** Remove the following in accordance with the factory service manual:

- LHS mud flap
- LHS Inner guard liner
- LHS Indicator lamp (if fitted)
- Air cleaner assembly
- Turbocharger air entry hose
- Intercooler Hose
- Fuse / relay box (remove from mount only)

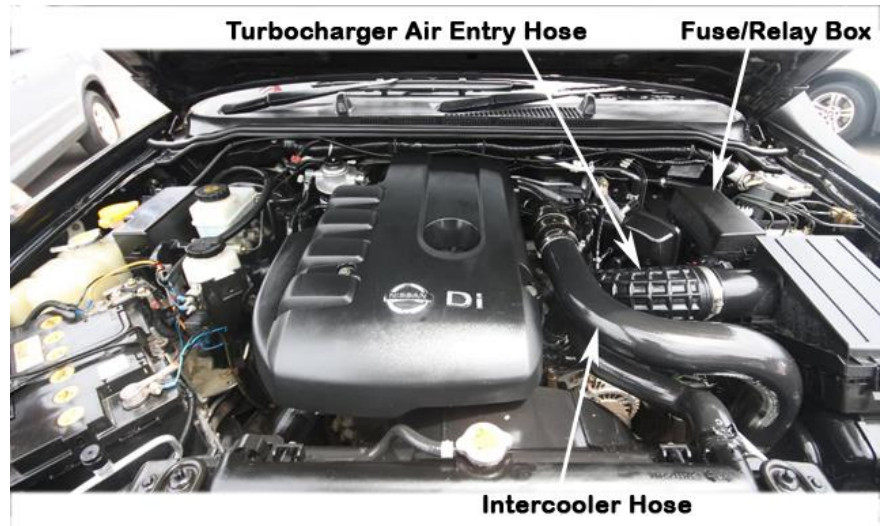

**2**

Remove and discard the foam insulator from between the inner and outer guard panel.



Tape the guard panel template (item 18) to the rear, upper and lower edges of the left hand guard panel using the indicator hole as a reference point only (some vehicle specifications may not have a guard mounted side indicator fitted).

Ensure that the template is stretched tight to the lower edge of the guard panel. Using a felt tip pen mark all hole positions.

Remove the template.

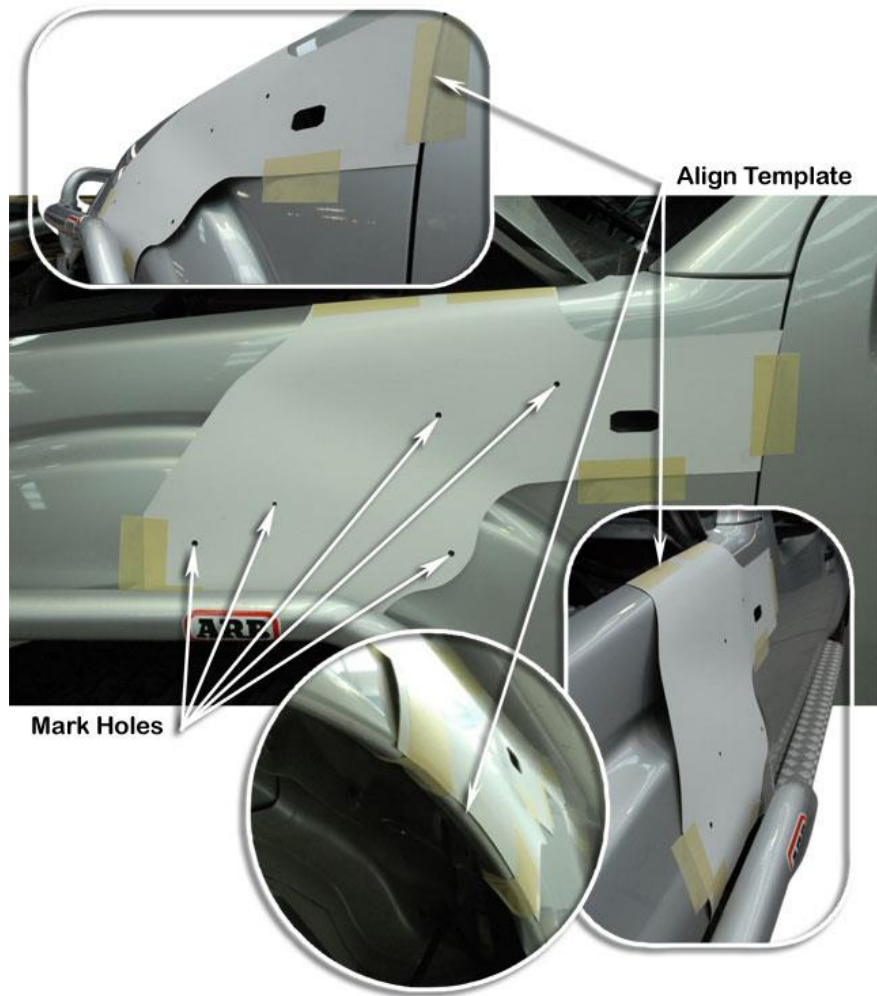

Drill a pilot hole for each marked hole position. Using the 105mm hole saw, drill the main hole in the guard panel. Using the step drill, drill the 4 mounting hole positions to 16mm.

Deburr and paint holes to prevent rust.

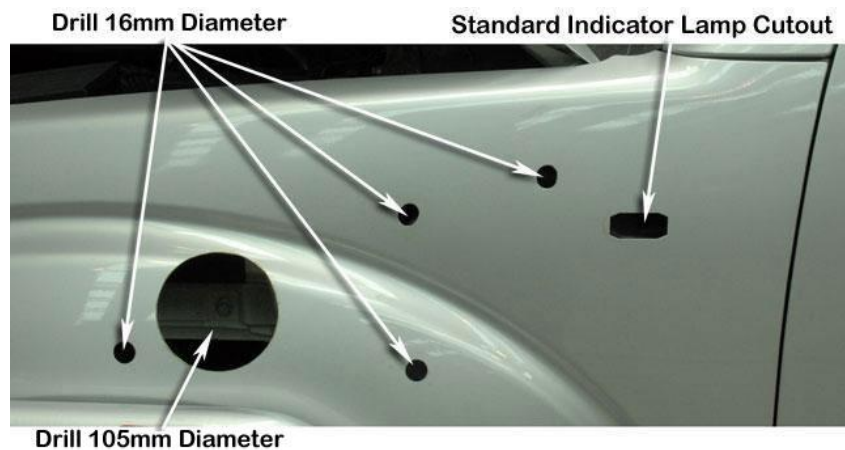

## NEW ZEALAND INSTALLATIONS ONLY :

Safari have developed 2 methods of Snorkel A pillar attachment, for the conventional method please proceed with the current document alternatively please see the link below for further instructions.

[www.safari4x4.co.nz/apillarmounting](http://www.safari4x4.co.nz/apillarmounting)

5

Install the upper mounting bracket (item 3) to the snorkel body using three hex bolts (Item 4).

Apply Loctite to all four studs (Item 7) and install the studs finger tight into the snorkel body (item 1) mounting inserts.



6

Remove the adhesive backing paper from the foam body gasket (Item 17).

Carefully align the foam body gasket to the back of the snorkel body (item 1), when correctly positioned, apply firm pressure all over, paying particular attention to the alignment along the top and front edges of the snorkel body.

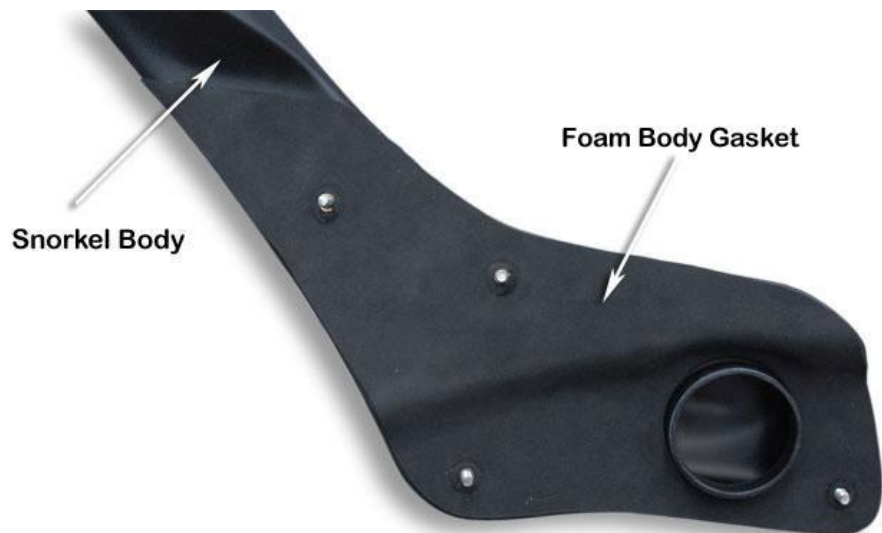

7

Place a strip of masking tape along the 'A' Pillar panel, carefully install the snorkel body onto the guard panel. Ensure there is adequate clearance around each of the mounting studs. (If necessary enlarge the 16mm mounting holes to achieve adequate clearance around each of the mounting studs to the guard panel using a round file or die grinder).



With the snorkel body correctly positioned onto the guard panel and adequate clearance around each mounting stud, mark the position of the upper mounting bracket (item 3) onto the masking tape as shown.

Remove the snorkel body from the vehicle. Remove the upper mounting bracket from the snorkel body.

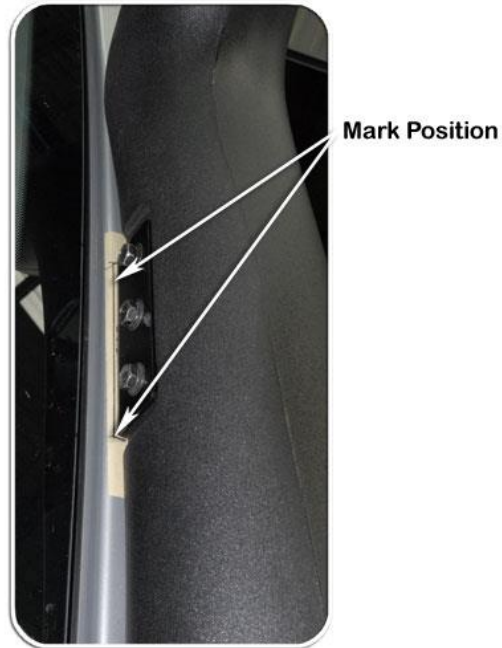

Align the upper mounting bracket with the marked position on the 'A' Pillar.

Mark the three mounting hole positions. Drill a pilot hole at each of the three marked hole positions. Drill each hole position to 8mm diameter with a step drill or 8mm drill bit.

Deburr and paint holes to prevent rust.

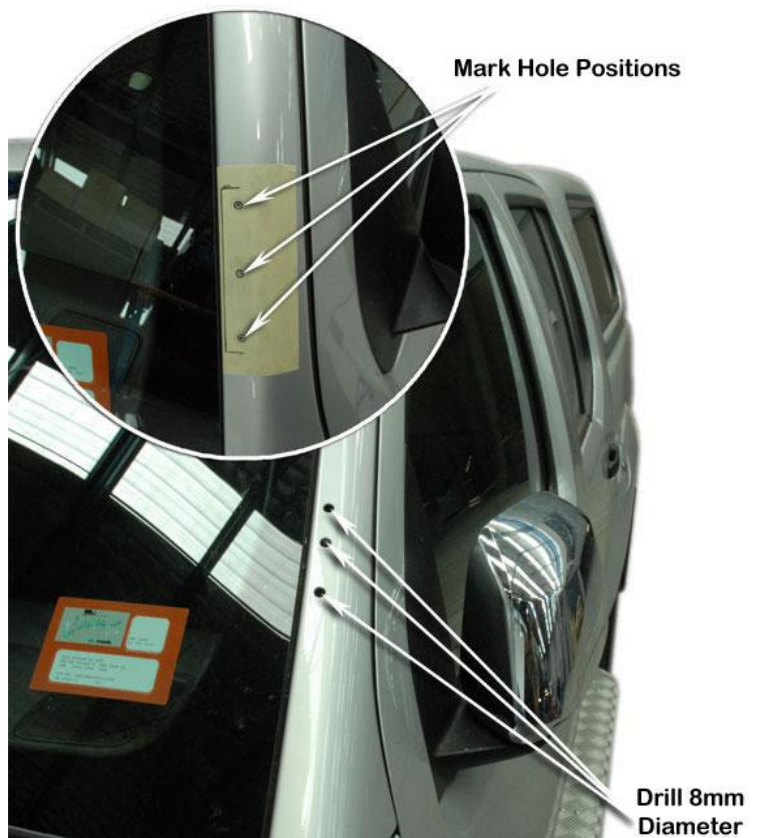

Install the plastic inserts (Item 6) into the 8mm diameter holes in the A-pillar.

Secure the upper mounting bracket (Item 3) to the A-pillar with three self-tapping screws (Item 5).

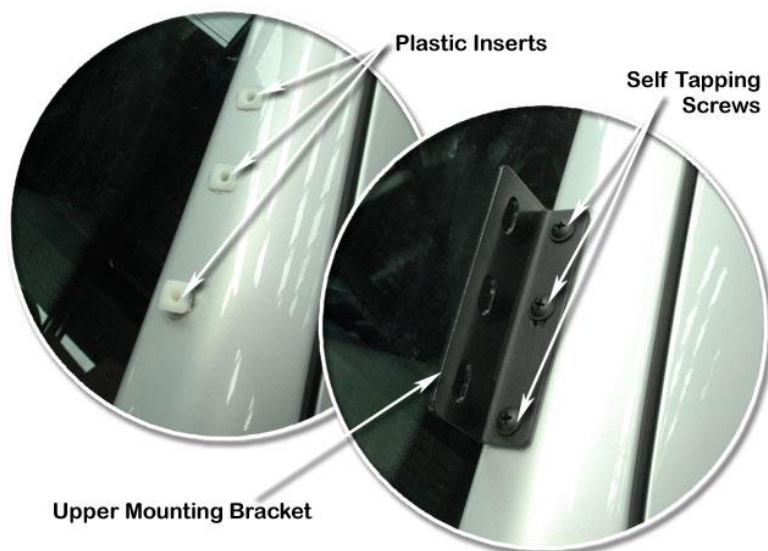

Unclip and remove all of the air cleaner inlet ducting from the air cleaner base as shown.

Remove and discard the foam seal from the air cleaner base.



Remove and discard the foam seal from the air inlet duct. Clean off any sticky residue left on the air inlet duct flange from the double sided tape.

Align the air inlet duct template (item 12) to the air inlet duct flange and the two lugs, tape the template to the flange with masking tape.

Mark all hole positions and remove the template.

Drill a pilot hole at each of the nine marked hole positions on the flange. Drill each hole position to 4.5mm diameter.

**Note: There are difference in the air inlet ducts between year models, early models did not have the two lugs.**

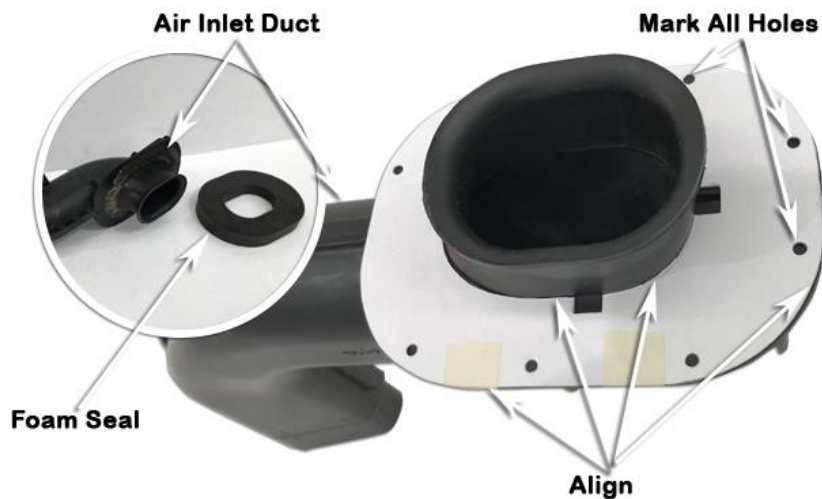

Remove the two or three steel clips holding the foam insert in place and remove the foam.

Apply Sikaflex sealant to the four clip holes and cut out in the air cleaner base as shown.

**Note: There are slight differences in the air cleaner bases between year models, early models do not have the foam inserts.**

Refit the foam and clips after sealing.

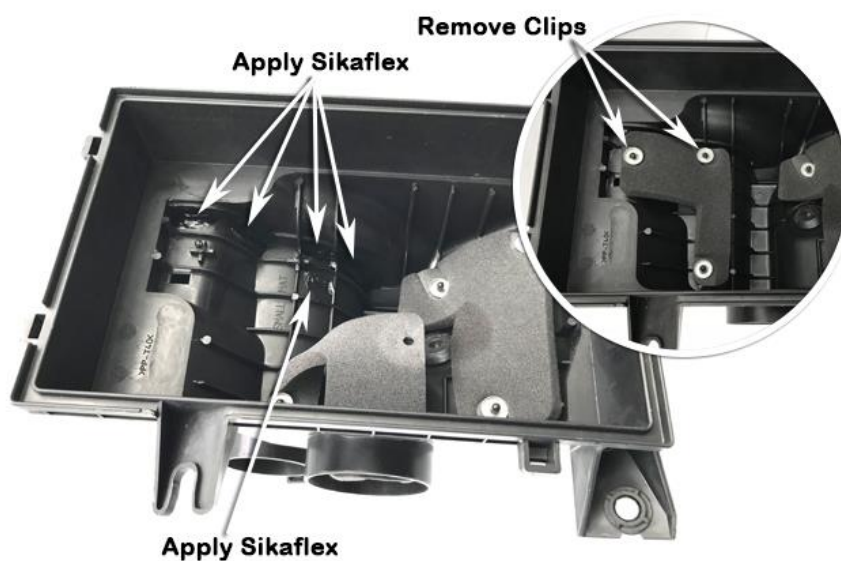

The air cleaner base has areas which are not totally sealed in various positions, apply a generous amount of Sikaflex to the unsealed areas of the air cleaner base as shown.



**INSTALLER OPTION :**

The air cleaner base has two small drain holes as shown. The drain holes can permit water to enter the air intake.

Safari advises that the drain holes should be sealed to ensure a watertight installation.





The air inlet duct is a two piece part which must be sealed correctly to prevent water from entering the air intake of the vehicle. Apply a generous amount of adhesive sealant to the upper and lower joins of the air inlet duct, ensure both sides are completely sealed as shown.



The air transfer duct is a two piece part which must be sealed correctly to prevent water from entering the air intake of the vehicle. Apply a generous amount of adhesive sealant to the upper and lower joins of the air transfer duct, ensure both sides are completely sealed as shown.



18

Apply Sikaflex sealant to the air transfer chamber outlet of the air cleaner base and to the air transfer duct outlet tube.

Install the air transfer duct back into the air cleaner base, ensure the duct clicks back into place correctly.

Clean-up any excess sealant to ensure a neat finish.

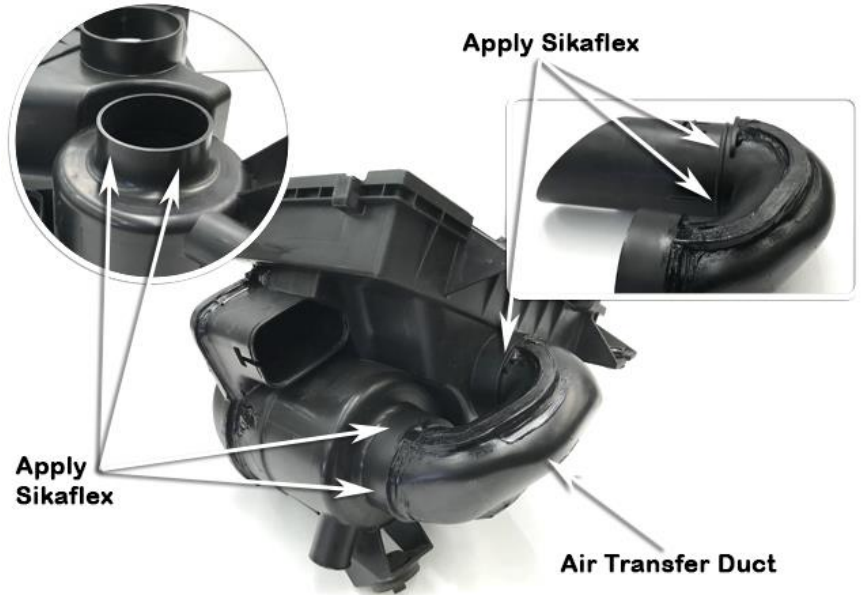

19

Align the hose support plate (item 11) to the air entry hose flange, install the support plate over the flange of the air entry hose (item 10) as shown.



20

Apply Sikaflex sealant to the mating surfaces of the air inlet duct and air entry hose flanges.

Install the air entry hose to the air inlet duct, insert all nine pop rivets (item 13) into position.

**Note the orientation of the one pop rivet, this pop rivet requires a 4mm body (item 14) installed on the rear side to prevent the plastic flange from splitting.**

With all nine pop rivets installed, work from the centre outwards and fasten all of the nine pop rivets with a pop rivet gun.

Clean-up any excess sealant to ensure a neat finish.

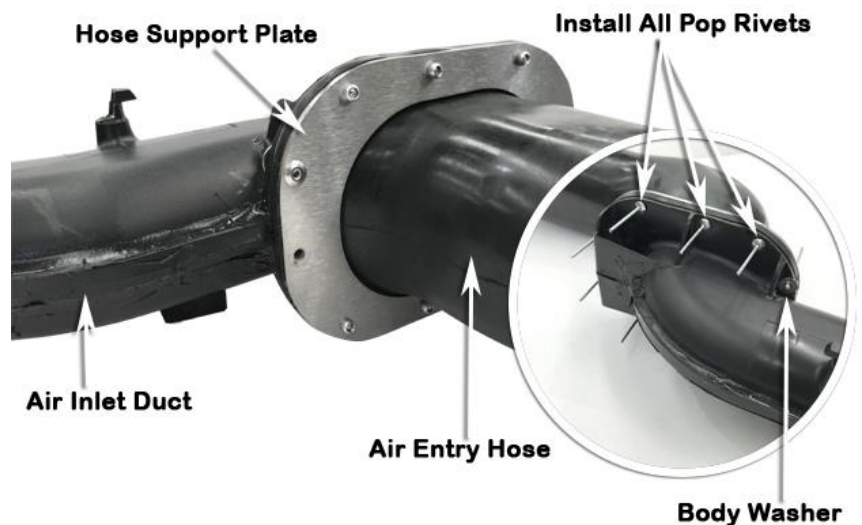

Screw a self tapping screw (item 5) into the tenth hole position in the hose support flange and into the air inlet duct.



Apply Sikaflex sealant to the air inlet duct and install the duct back into the air cleaner base, ensure the duct clicks back into place correctly.

Clean-up any excess sealant to ensure a neat finish.



Apply silicone spray or similar lubricant to the outer surface of the air entry hose (item 10).

Install the air cleaner base / air entry hose assembly back into the vehicle, guiding the air entry hose through the hole in the inner guard panel as shown.

Rotate the assembly towards the front of the vehicle until the hose is completely through.

Locate the air cleaner base onto the two standard mounting pins, fasten the air cleaner base with standard mounting bolt.

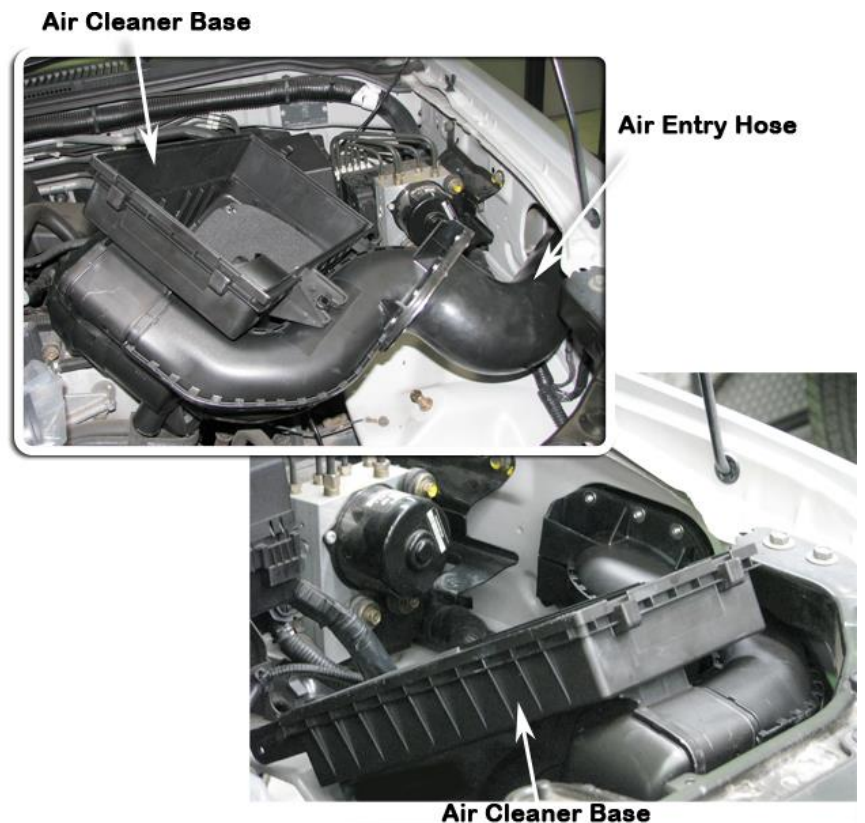



Install the 80/100mm hose clamp (item 15) loosely over the air entry hose (item 10).

Ensure the inside of the hose is completely free of lubricant from the previous step.

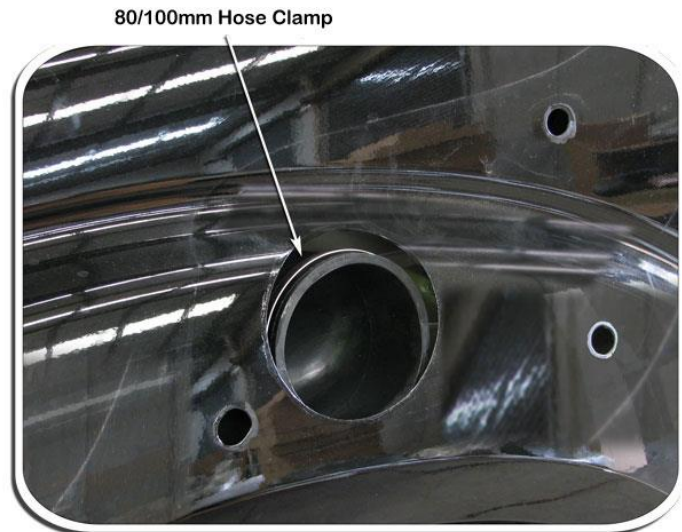

Carefully install the snorkel body (item 1) to the guard panel, guiding the snorkel body outlet snout into the air entry hose (item 10), align the snorkel body to the guard panel and upper mounting bracket.

When correctly aligned, fasten the snorkel body to the guard panel with body washers (item 8) and nyloc nuts (item 9).

Fasten the snorkel body to the upper mounting bracket with hex bolts (item 4).

Ensure the air entry hose (item 10) is correctly installed onto the snorkel body outlet snout and tighten the 80/100mm hose clamp (item 15).

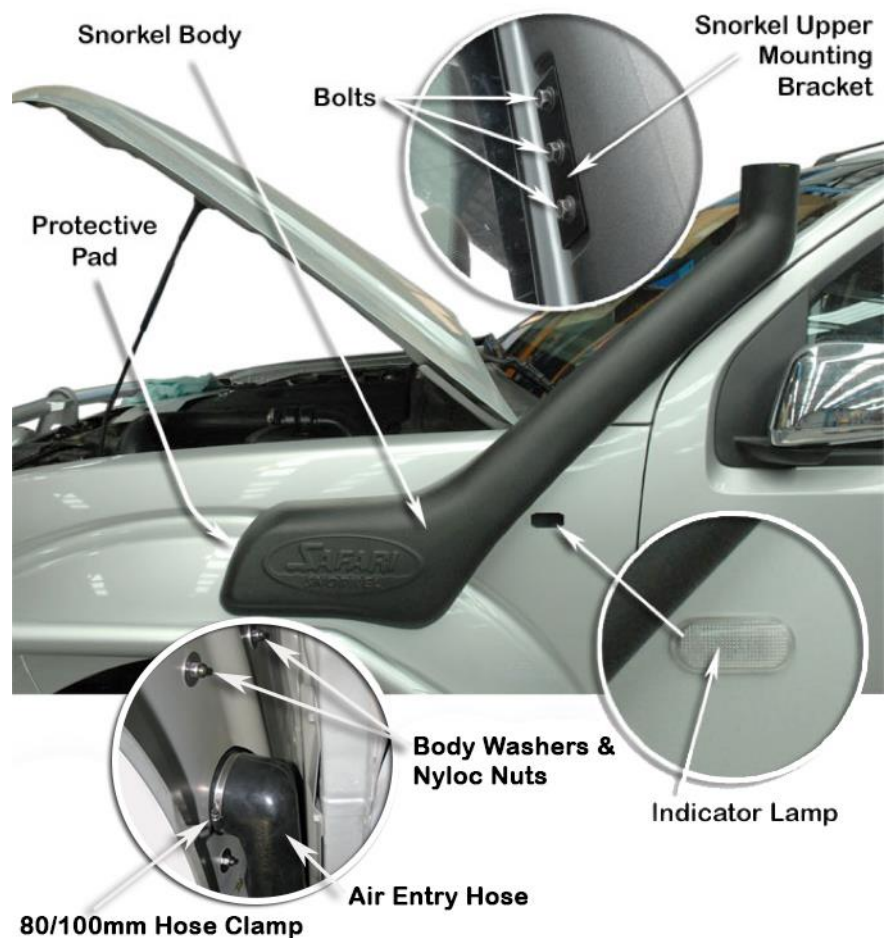



26

Install the black hose clamp (item 16) loosely over the base of the air ram assembly (item 2). Install the air ram assembly onto the snorkel body.

Align the air ram assembly and tighten the black hose clamp (item 16).



27

Install the LHS indicator lamp (if fitted to vehicle), inner guard liner, mud flap, air filter element, air cleaner housing lid, fuse / relay box, turbocharger air entry hose, intercooler hose, connect the air mass sensor wiring and any other items that may have been removed during the snorkel installation process.

Road test vehicle.

28

**N.B:** It is the installer's responsibility to ensure that all connections are water tight.