



SS16HFB

SAFARI V-SPEC SNORKEL
Nissan GU Patrol Series 1-3
3.0L 4cyl Turbo Diesel (ZD30-DDTi Engine)



01/06/11

Parts List

ITEM	PART NO	DESCRIPTION	QTY
1	485-133-500	BODY - SNORKEL (SS15HFB)	1
2	000-135-800	3 ½" AIR RAM ASSEMBLY	1
3	485-032-500	BRACKET - UPPER MOUNTING	1
4	000-002-100	BOLT - HEX - 6mm x 1.0 x 14mm (SEMS) - S/S	2
5	000-951	SCREW - S/T - 4.2mm x 13mm - S/S	3
6	000-960	INSERT - PLASTIC	3
7	000-110	STUD - 8mm x 1.25 x 25mm - S/S	5
8	000-311-300	WASHER - BODY - 8mm x 32mm - S/S	5
9	000-205-300	NUT - NYLOC - 8mm x 1.25mm - S/S	5
10	485-024-000	HOSE - SNORKEL OUTLET	1
11	485-025-000	JOINER - 90mm OD x 60mm Long	1
12	485-024-300	HOSE - AIR CLEANER ENTRY	1
13	000-909	CLAMP - HOSE 80/100mm	1
14	000-910	CLAMP - HOSE 90/110mm	2
15	000-1911	CLAMP - HOSE 100/120mm	1
16	000-914/B	CLAMP - HOSE - No. 56 (BLACK)	1
17	485-017-500	TEMPLATE - GUARD PANEL	1

Installation Guide

Fitment to:

- Left Hand Side

Fitting Time:

- 150min

Special Tools:

- 111mm Hole saw
- Step drill
- Touch-up paint
- Loctite 243 (Threadlocker)
- Scriber
- Masking tape
- Body Saw (Reciprocating) / Hacksaw

Prior to commencing the installation, it is the installer's responsibility to verify that all components and particularly the template (Item 17) are correct.

1

Remove the following in accordance with the factory service manual.

- LHS Guard Liner
- LHS mudflap
- LHS Indicator Assembly
- Air Cleaner Assembly
- Radio Antenna (if fitted)

2

Remove and discard the air intake ducting and foam isolator from the inner guard (shown).

Hint: The inner guard duct is retained to the internal panel by five 6mm hex bolts and adhesive sealant.



3

Align the guard panel template (item 17) with the upper and rear edges of the LHS guard panel. Tape the template to the guard panel with masking tape.

Mark all hole positions with a felt tip pen and remove the template.

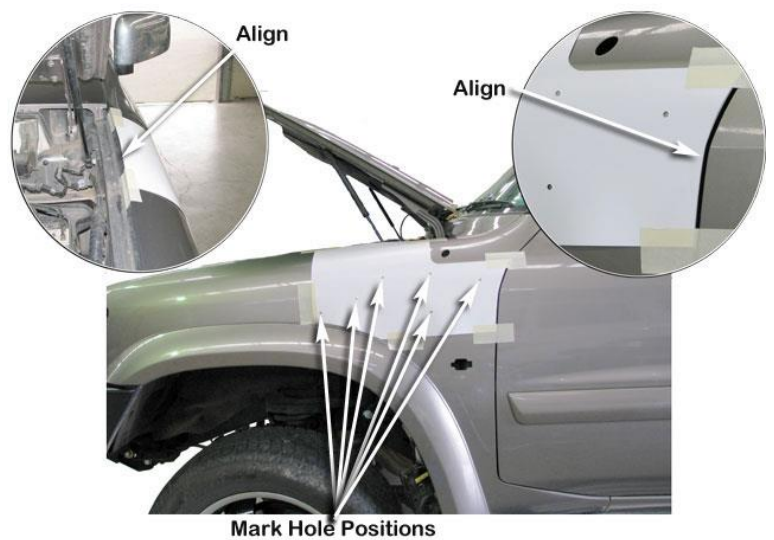

4

Drill a pilot hole for each of the marked hole positions.

Use a 111mm diameter hole saw to drill the snorkel body outlet hole position in the guard panel.

Use a step drill to drill the five mounting holes to 16mm diameter.

Deburr and paint holes to prevent rust.

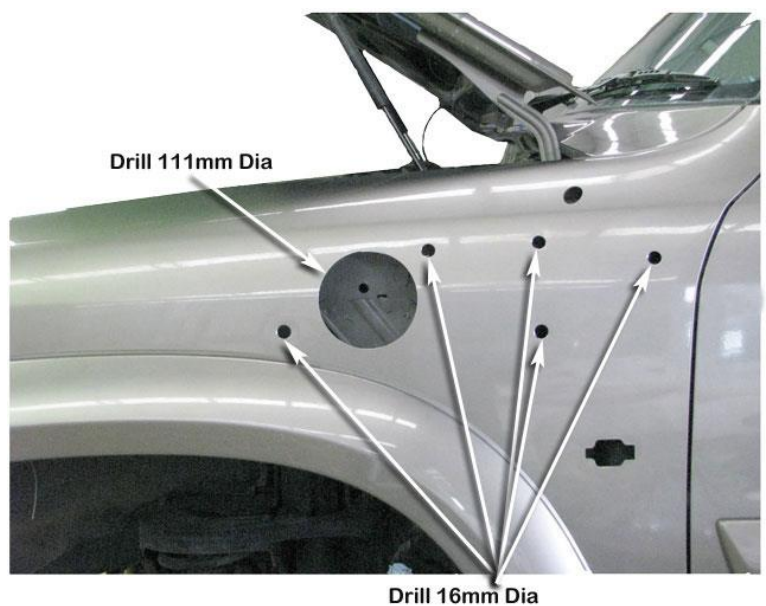

NEW ZEALAND INSTALLATIONS ONLY :

Safari have developed 2 methods of Snorkel A pillar attachment, for the conventional method please proceed with the current document alternatively please see the link below for further instructions.

www.safari4x4.co.nz/apillarmounting

5

Install the upper mounting bracket (item 3) to the snorkel body (item 1) with hex bolts (item 4).

Apply Loctite 243 to each of the stainless steel mounting studs (item 7) and install the studs finger tight into the snorkel body (item 1) mounting inserts.

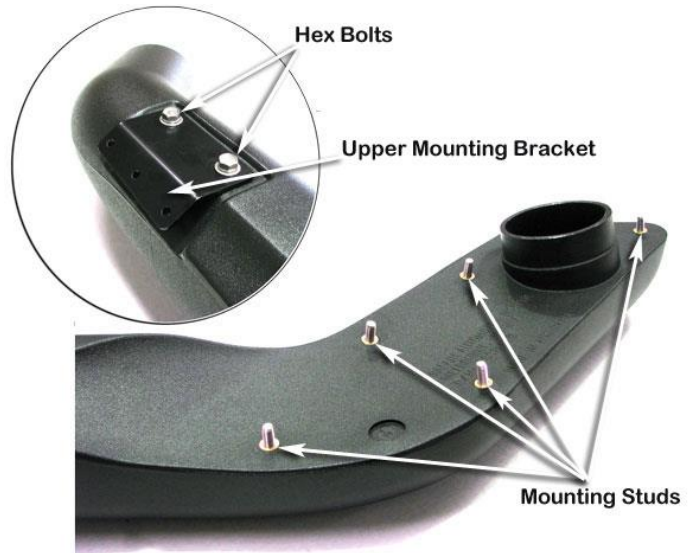

6

Place a strip of masking tape along the A-pillar panel.

Carefully install the snorkel body (item 1) to the guard panel.

With the snorkel body correctly positioned, use the scribe to mark the position of the upper mounting bracket (item 3) onto the masking tape as shown.



Remove the snorkel body (item 1) from the vehicle and remove the upper mounting bracket (item 3) from the snorkel body.

Position the upper mounting bracket onto the A-pillar and align the bracket to the scribe markings on the masking tape. Mark the three mounting hole positions with a felt tip pen.

Drill a pilot hole at each of the three marked hole positions. Drill each hole position to 8mm diameter with a step drill or 8mm drill bit.

Deburr and paint holes to prevent rust.

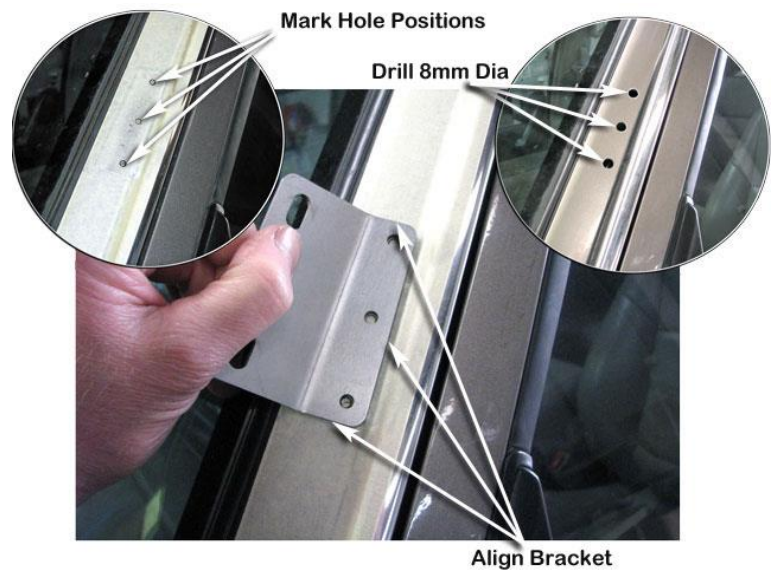

Install the plastic inserts (item 6) into the upper mounting bracket holes in the A-pillar.

Secure the upper mounting bracket (item 3) to the A-pillar with self tapping screws (item 5).

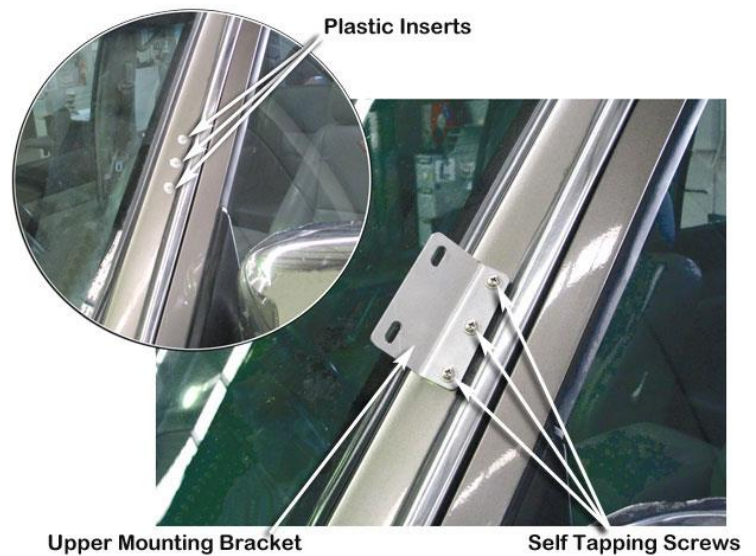

Install the air cleaner entry hose (item 12) through the hole in the internal panel and the air intake hole in the inner guard panel.

Hint: Squash the end of the hose inwards and tape to hold whilst installing the hose through the holes as shown.



10

Mark the circumference of the joiner (Item 11) 30mm from the end.

Insert the joiner into the air cleaner entry hose (Item 12) and align the 30mm mark to the end of the hose.

Secure the joiner in place with a 90/110mm hose clamp (Item 14).

Install the second 90/110mm hose clamp (Item 14) loosely over the joiner and install the snorkel outlet hose (Item 10) over the joiner (Item 11).

Do not tighten the hose clamp at this stage.

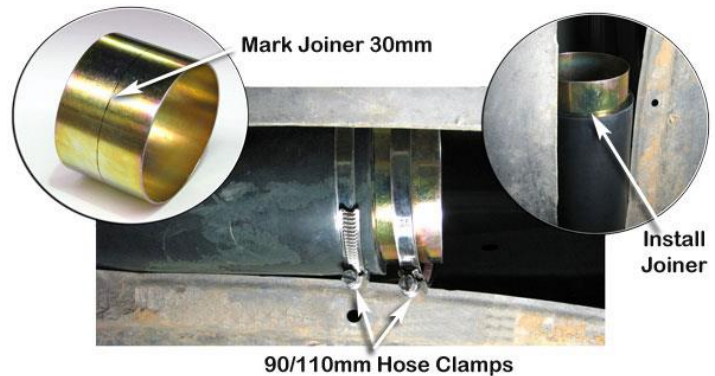

11

Install the 100/120mm hose clamp (item 15) loosely over the snorkel outlet hose (item 10) and align the hose with the hole in the guard panel.

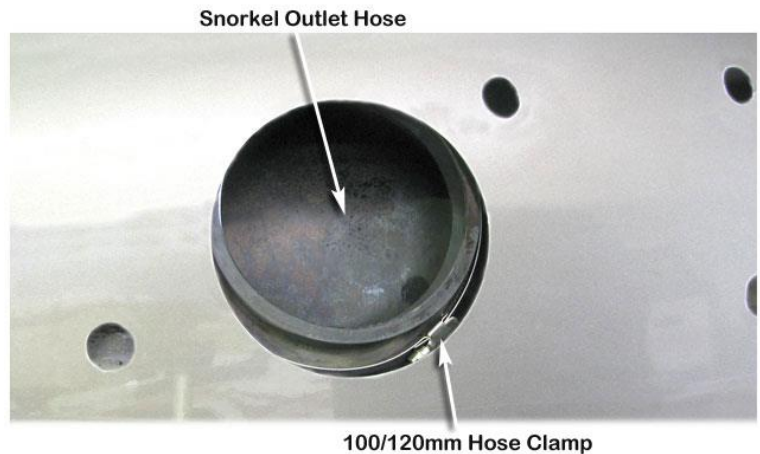

12

Carefully install the snorkel body (item 1) to the guard panel guiding the snorkel body outlet snout into the snorkel outlet hose (item 10), align the snorkel body to the guard panel and upper mounting bracket.

When correctly aligned fasten the snorkel body to the guard panel with body washers (item 8) and nyloc nuts (item 9).

Fasten the snorkel body to the upper mounting bracket with hex bolts (item 4).

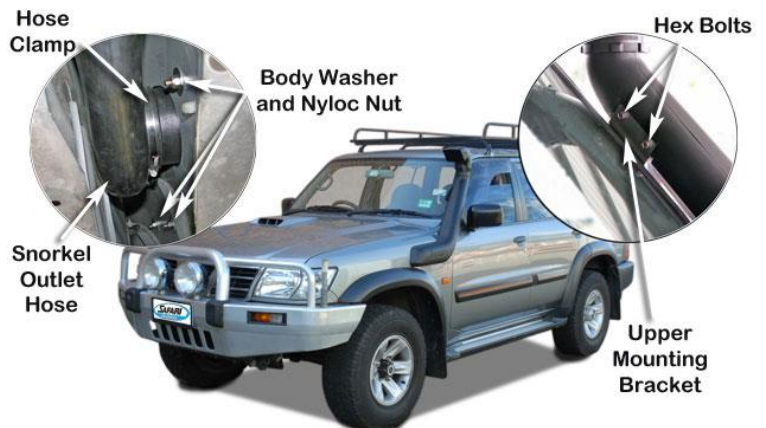

13

Use a body saw / hacksaw to remove the flange and rib on the air cleaner base inlet, neaten the cuts with a file.

Ensure the air cleaner housing is free of any plastic filings from the cutting process.

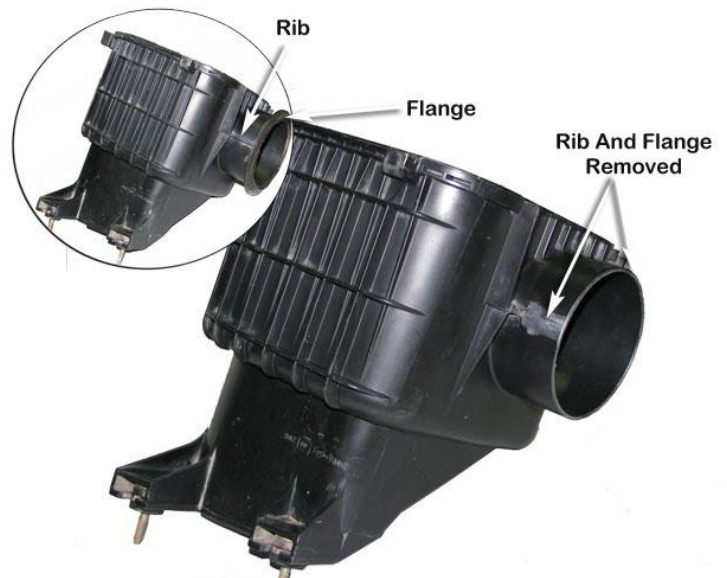

14

INSTALLER OPTION

The air cleaner housing base contains one small drain hole. This hole can permit water to enter the air intake.

It is up to the installer to decide whether the drain hole should be sealed.



15

Install the 80/100mm hose clamp (item 13) loosely over the air cleaner entry hose (item 12).

Install the air cleaner base whilst guiding the modified air cleaner snout into the air cleaner entry hose.

Secure the air cleaner base with the original mounting hardware.

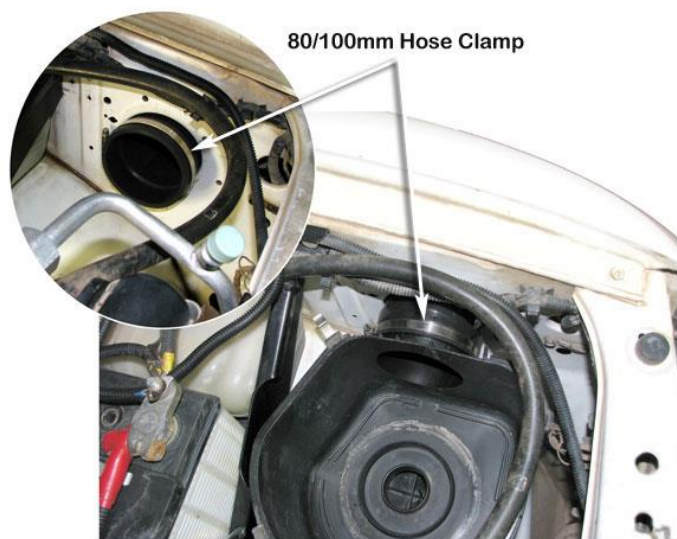

16

Align the two hoses (items 10 & 12) for best fitment, ensure that the snorkel outlet hose (item 10) is installed hard up against the shoulder of the snorkel body outlet snout, tighten the 100/120mm hose clamp (item 15).

Tighten the 90/110mm hose clamp (item 14) at the joiner and the 80/100mm hose clamp (item 13) at the air cleaner entry.



17

Install the air cleaner element, air cleaner lid and any other components removed during the installation process.

18

Install the black hose clamp (item 16) loosely over the base of the air ram assembly (item 2).

Install the air ram assembly onto the snorkel body.

Align the air ram assembly and tighten the black hose clamp (item 16).



19

Re-install the radio antenna, guard liner, mud flap and any other items that may have been removed during the snorkel installation process.

20

N.B: It is the installer's responsibility to ensure that all connections are watertight.