



4X4 ENGINEERING

SS1410HF

SAFARI V-SPEC SNORKEL
VOLKSWAGEN AMAROK V6 TDI550
3.0L TDI V6 Engine



01/07/2017

Parts List

ITEM	PART NO.	DESCRIPTION	QTY
1	910-133-000	BODY - SNORKEL (SS1400HF)	1
2	000-135-800	3 ½" AIR RAM ASSEMBLY	1
3	910-032-000	BRACKET - UPPER MOUNTING	1
4	000-002-100	BOLT - HEX - 6mm x 1.0 x 14mm (SEMS)	2
5	000-951	SCREW - S/T - 4.2mm x 13mm - S/S	3
6	000-960	INSERT - PLASTIC	3
7	000-110	STUD - 8mm x 1.25 x 25mm - S/S	6
8	000-311-300	WASHER - BODY - 8mm x 30mm - S/S	6
9	000-205-300	NUT - NYLOC - 8mm x 1.25mm - S/S	6
10	910-024-200	HOSE - AIR ENTRY - (Flanged Mounting)	1
11	910-025-300	PLATE - CLAMPING - (Upper)	1
12	910-025-325	PLATE - CLAMPING - (Rear)	1
13	910-025-350	PLATE - CLAMPING - (Front)	1
14	910-025-375	PLATE - CLAMPING - (Lower)	1
15	910-025-400	PLATE - AIR FILTER SUPPORT	1
16	000-958-150	POP RIVET - 4mm x 13mm	12

17	000-300-350	WASHER - BODY - 4mm x 12mm - S/S	4
18	910-959-000	CAP - AIR INLET BLANK-OFF	1
19	000-908	CLAMP - HOSE - 70/90mm	1
20	000-910	CLAMP - HOSE - 90/110mm	1
21	000-914/B	CLAMP - HOSE - No. 56 (BLACK)	1
22	910-967-200	PLATE - INNER GUARD SUPPORT	1
23	910-967-650	PLATE - INNER GUARD SUPPORT SPACER	1
24	000-958-525	POP RIVET - 4.8mm x 10mm	8
25	910-217-000	TEMPLATE - AIR CLEANER INLET (Side Upper)	1
26	910-217-100	TEMPLATE - AIR CLEANER INLET (Side Lower)	1
27	910-217-200	TEMPLATE - AIR CLEANER INLET (Lower)	1
28	910-017-400	TEMPLATE - INNER GUARD	1
29	910-017-000	TEMPLATE - GUARD PANEL	1

Installation Guide

Fitment to:

- Right Hand Side

Fitting Time:

- 210min

Special Tools:

- 83mm Hole saw
- Body Saw (Reciprocating)
- Step Drill
- 4.0mm & 5.0mm Drill Bits
- Pop Rivet Gun
- Grinder & File
- Masking Tape
- Touch-up Paint
- Prep-wash
- Sikaflex 227 Adhesive Sealant
- Loctite 243 (Thread Lock)

Prior to commencing the installation, it is the installer's responsibility to verify that all components and particularly the guard panel template (Item 29) are correct.

1 Remove the following in accordance with the factory service manual:

- Mud Flap (Right Hand Front)
- Guard Liner (Right Hand Front)
- Windscreen Washer Bottle Filler Neck
- Windscreen Washer Bottle
- Air Cleaner Lid
- Air Cleaner Base
- Side Indicator (if fitted to vehicle)

2

Remove and discard the air cleaner inlet duct.



3

Align the guard panel template (Item 29) to the rear and upper edges of the right hand guard panel.

Tape the template to the guard panel with masking tape.

Mark all six mounting hole positions the two hole saw centre positions and the upper and lower cut out sections with a felt tip pen.

Remove the template.

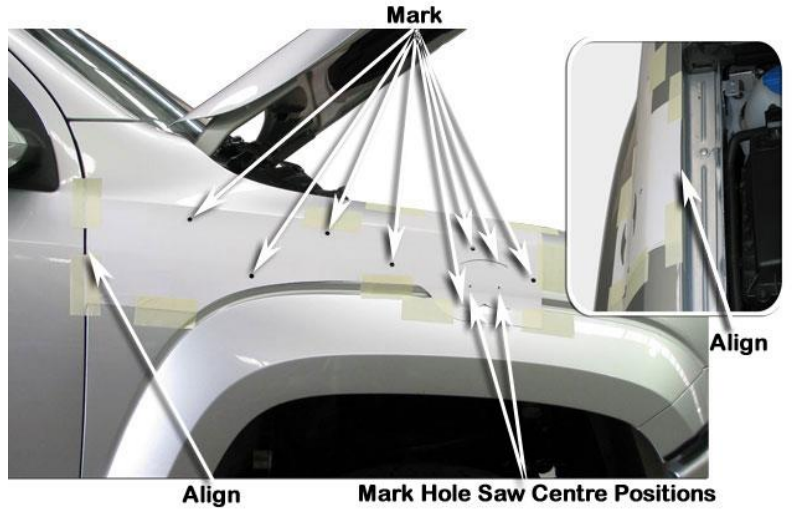

4

Apply masking tape to guard panel and flare to ensure no metal filings are trapped between the flare and guard panel as shown.

Drill a pilot hole for each of the marked hole positions.

Use a 83mm diameter hole saw to drill the snorkel body outlet hole positions. Ensure the hole saw is square to the guard panel whilst drilling.

Use a body saw to trim away the upper and lower sections of the guard panel and flare between the two 83mm diameter holes as per the template cut outs.

Use a step drill to drill the six mounting holes to 16mm diameter.

Deburr and paint all holes to prevent rust.

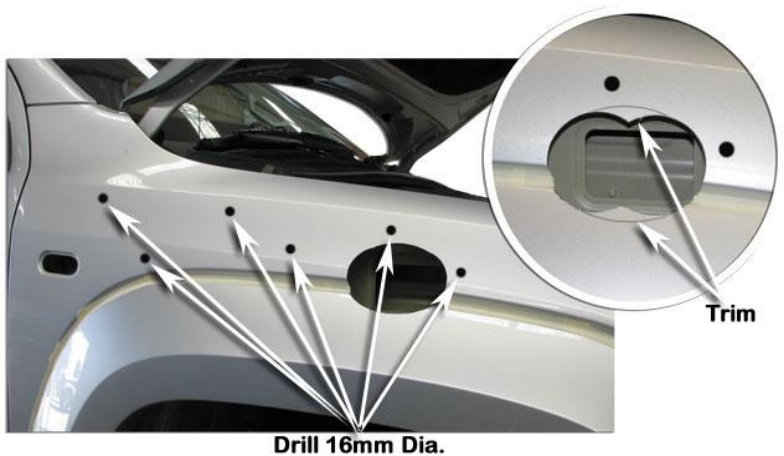
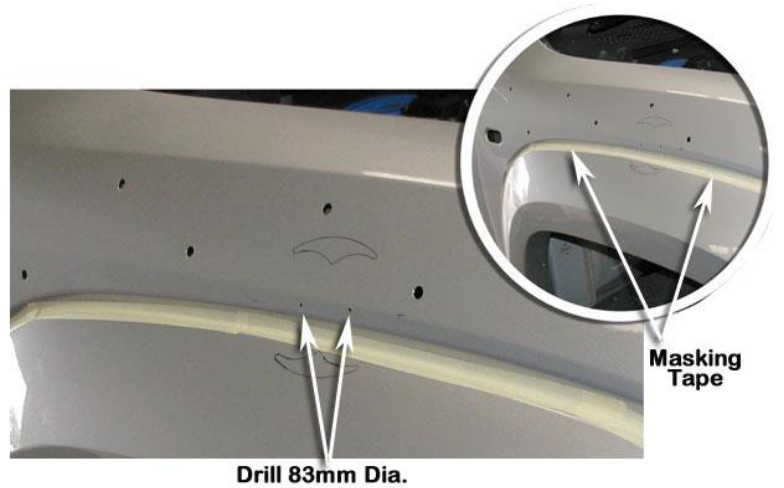

5

Apply Sikaflex adhesive sealant to the gap between the flare and guard panel as shown.

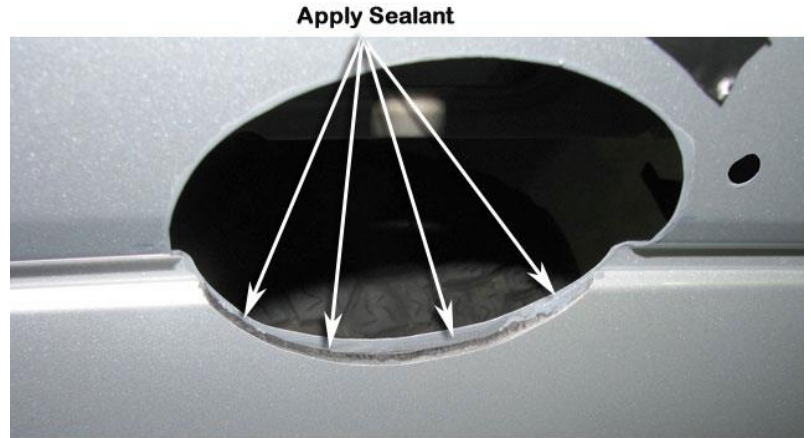

NEW ZEALAND INSTALLATIONS ONLY :

Safari have developed 2 methods of Snorkel A pillar attachment, for the conventional method please proceed with the current document alternatively please see the link below for further instructions.

www.safari4x4.co.nz/apillarmounting

6

Install the upper mounting bracket (item 3) to the snorkel body (item 1) with hex bolts (item 4).

Apply loctite 243 to each of the stainless steel mounting studs (item 7) and install the studs finger tight into the snorkel body (item 1) mounting inserts.

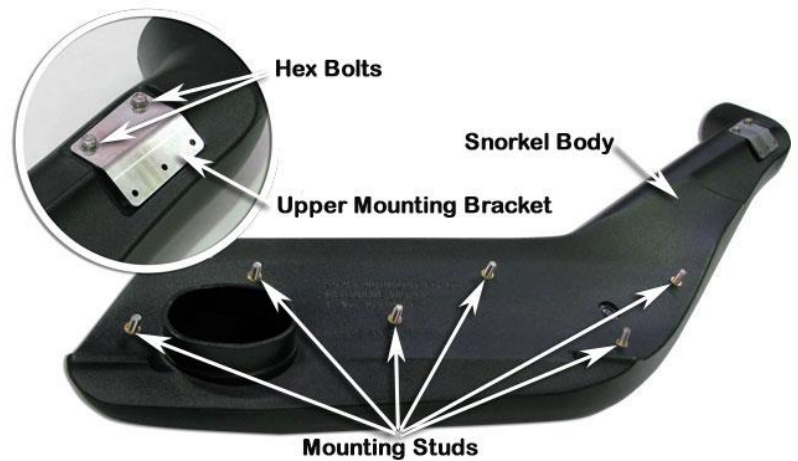

7

Place a strip of masking tape along the A-pillar panel.

Carefully install the snorkel body (item 1) to the guard panel.

With the snorkel body correctly positioned, mark the position of the upper mounting bracket onto the masking tape as shown.



8

Remove the snorkel body (item 1) from the vehicle and remove the upper mounting bracket (item 3) from the snorkel body.

Position the upper mounting bracket onto the A-pillar and align the bracket to the marked bracket position on the masking tape. With the bracket correctly positioned mark the three mounting hole positions with a felt tip pen.

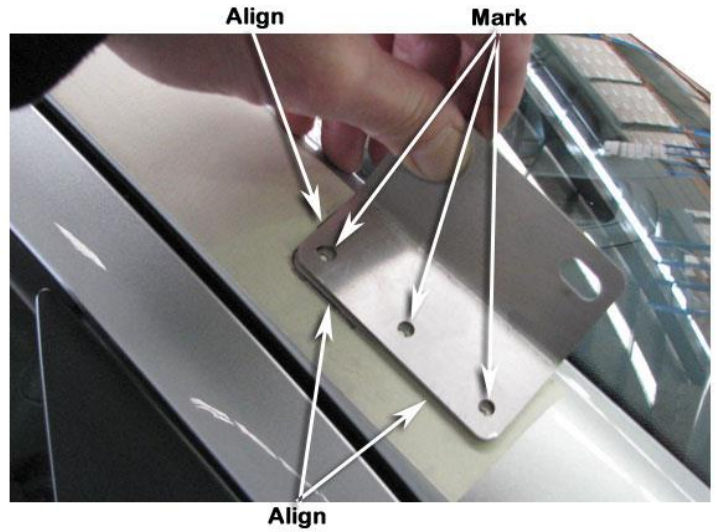

9

Drill a pilot hole at each of the three marked hole positions.

Drill each hole position to 8mm diameter with a step drill or 8mm drill bit.

Deburr and paint holes to prevent rust.

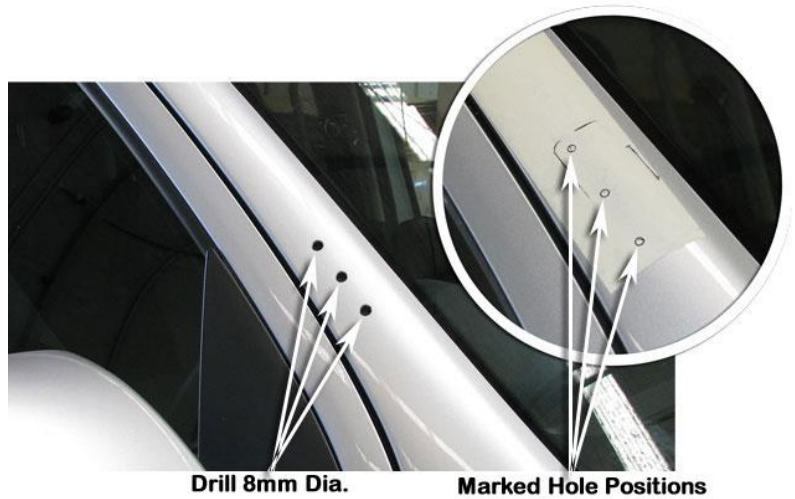

10

Install the plastic inserts (item 6) into the 8mm diameter holes in the A-pillar.

Secure the upper mounting bracket (item 3) to the A-pillar with three stainless steel self-tapping screws (item 5).

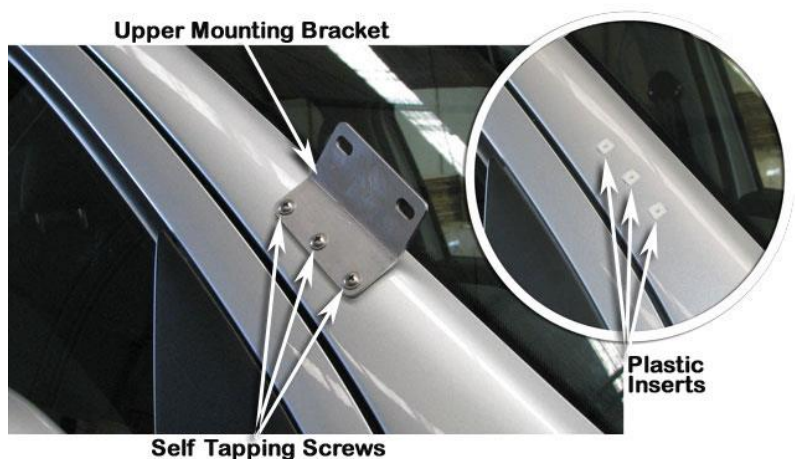

Unclip the wiring loom and coolant by-pass hose from their mounting positions, align the inner guard template (item 28) to the top edge, wiring loom mounting hole and the coolant by-pass rectangle mounting slots of the inner guard panel as shown.

Tape the template to the inner guard panel with masking tape. Ensure the template follows the contours of the inner guard panel.

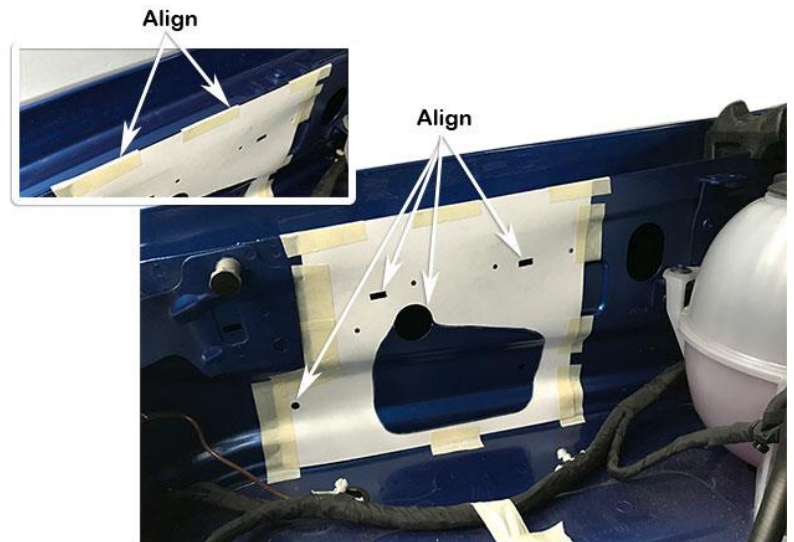

With the template correctly taped to the inner guard panel, mark the required cut-out and the four hole positions onto inner guard panel as shown.

Remove the template.

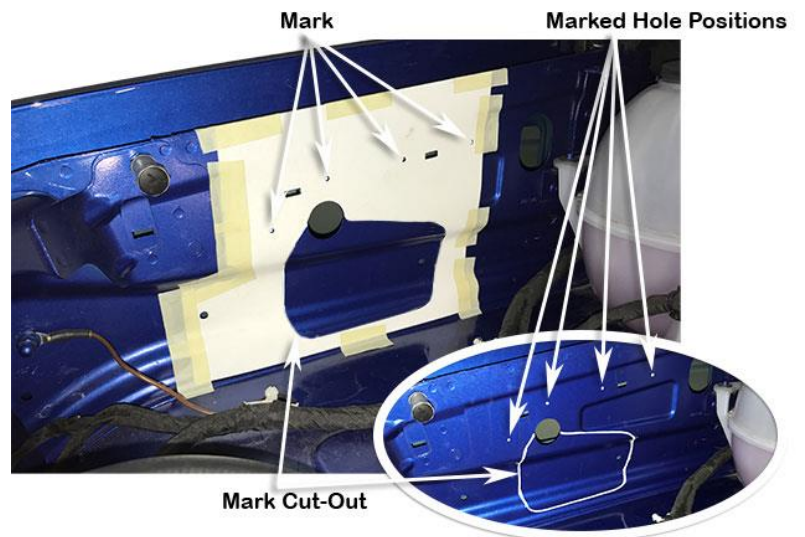

Drill a pilot hole at each of the marked hole positions.

Drill the four hole position to 5.0mm diameter.

Using the body saw, cut the hole in the inner guard panel (cutting on the outside of the line), as marked from the template.

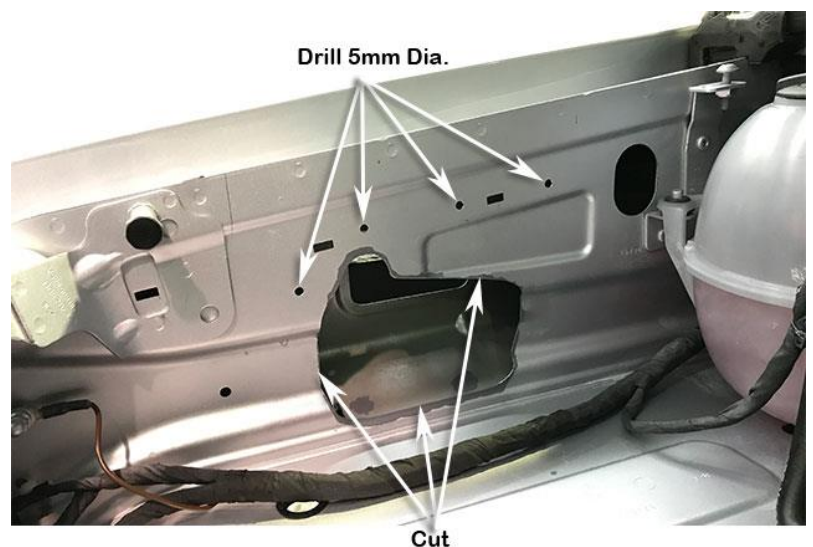

Align and tape the inner guard support spacer plate (item 23) to the inner guard support plate (item 22)

Install the inner guard support plate and spacer plate to the inner guard panel, loosely install four pop rivets (item 24) to hold the support plate in position. Using a felt tip pen or the 5.0mm drill bit mark the four mounting hole positions onto the inner guard panel.

Remove the pop rivets, inner guard support plate and spacer plate.

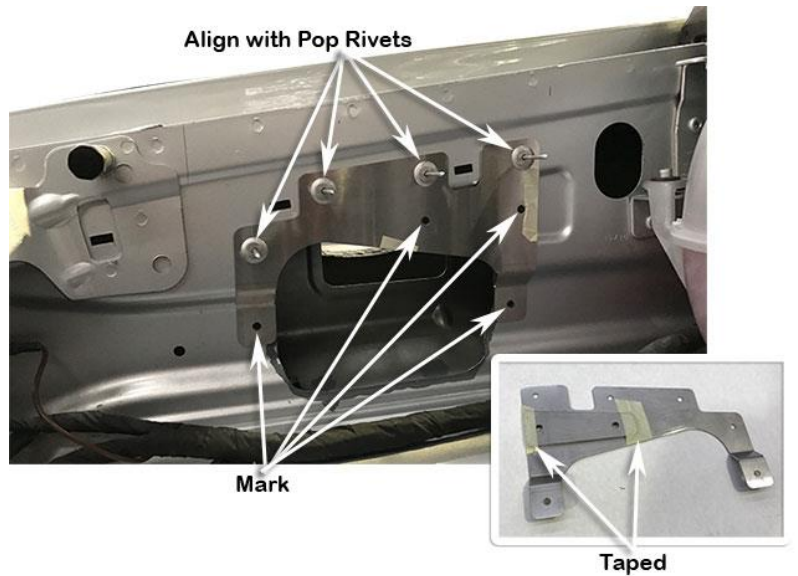

Drill a pilot hole at each of the four marked hole positions, drill the four hole positions to 5.0mm diameter.

Deburr and paint all holes and the cut section of the inner guard panel.

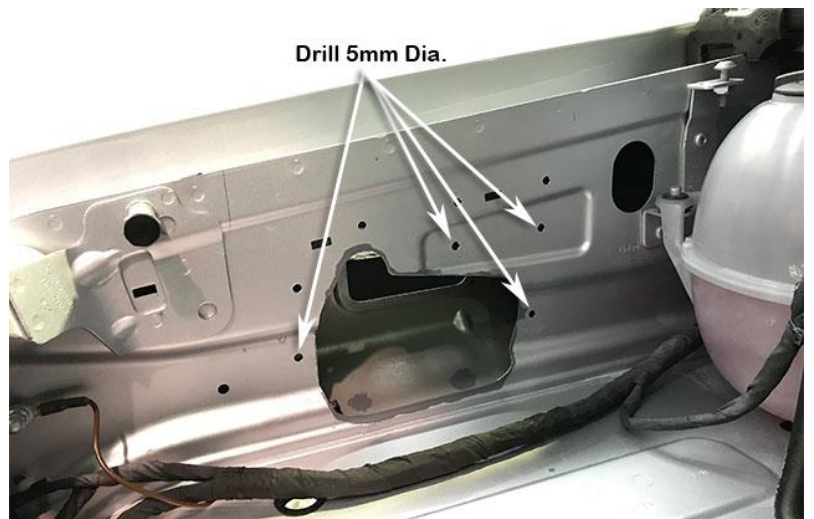

Remove and discard the mounting clips (shown) from the wiring loom.

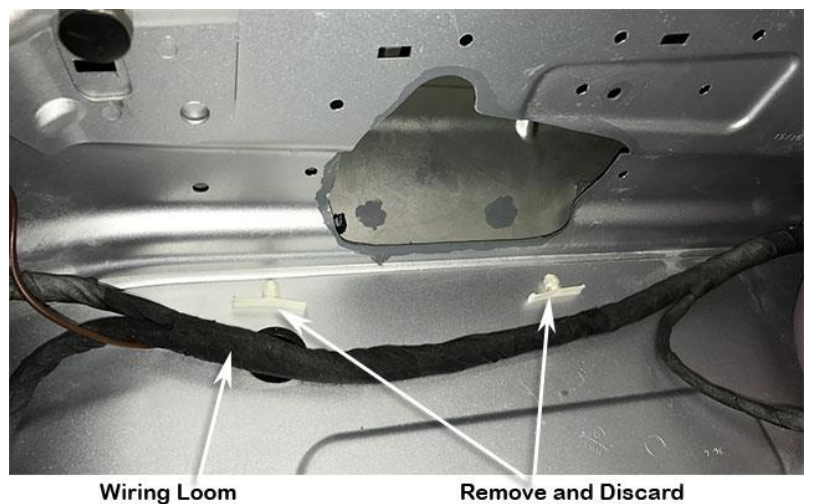

17

Apply a smear of Sikaflex adhesive sealant to the inner guard support spacer plate (item 23), align the spacer to the two holes in the support plate and press down firmly.

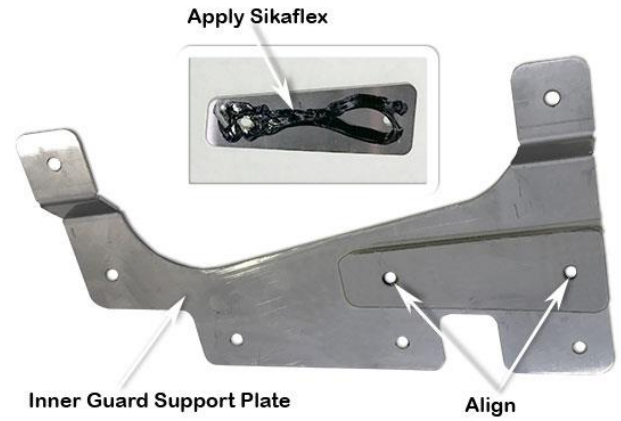

18

Apply a generous amount of Sikaflex adhesive sealant to the inner guard support plate (item 22) and spacer plate (item 23).



19

Install the support plate and spacer plate with Sikaflex adhesive sealant applied to the inner guard panel, install all eight pop rivets and secure the support plate and spacer to the inner guard panel. Clean-up any excess sealant to ensure a neat finish.

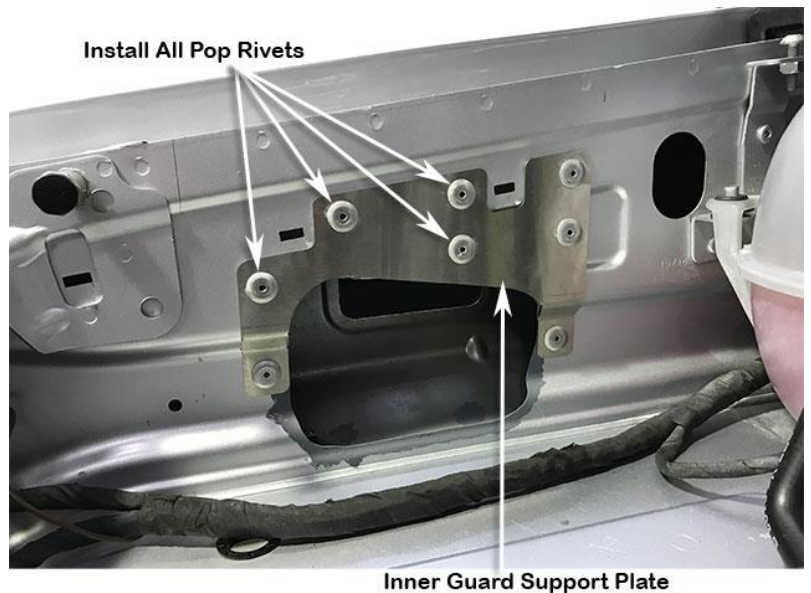

Measure down 25mm from under the air cleaner base top shoulder and mark the five air cleaner base ribs as shown.

Use a grinder or sharp knife to remove the lower sections of the 5 ribs from the side of the air cleaner base.

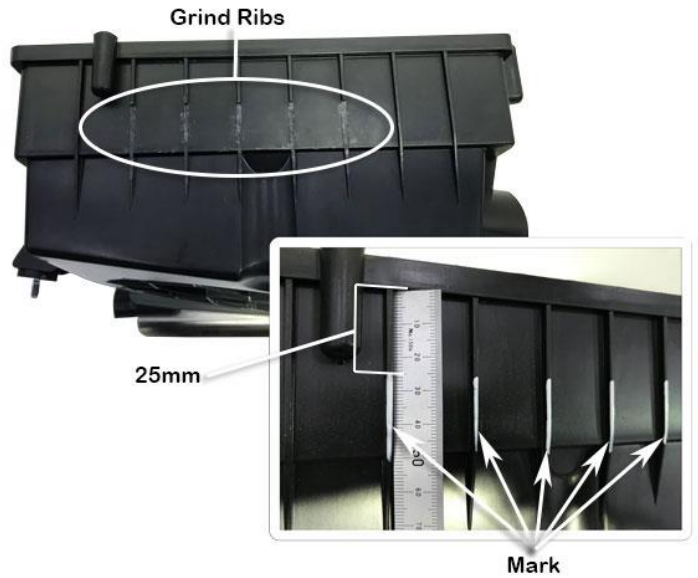

Align the air cleaner inlet template (item 25) onto the side of the air cleaner base as shown.

Mark all four hole positions with a paint marker pen.

Remove the template.

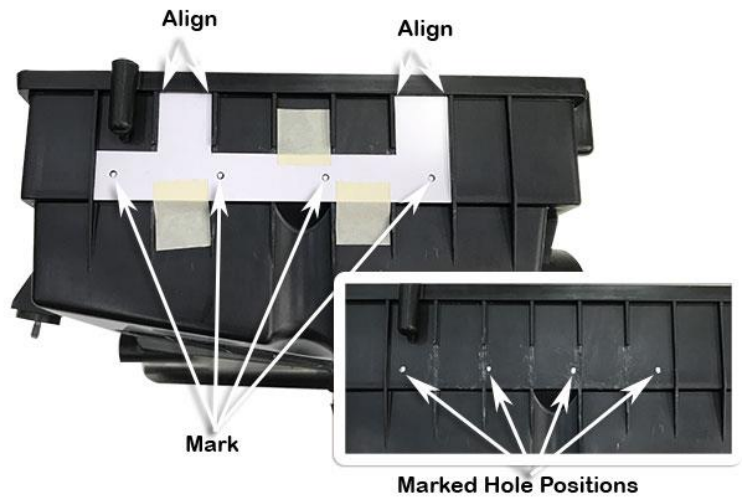

Align the air cleaner inlet template (item 26) onto the side of the air cleaner base as shown.

Mark the cut-out section and all four hole positions with a paint marker pen.

Remove the template.

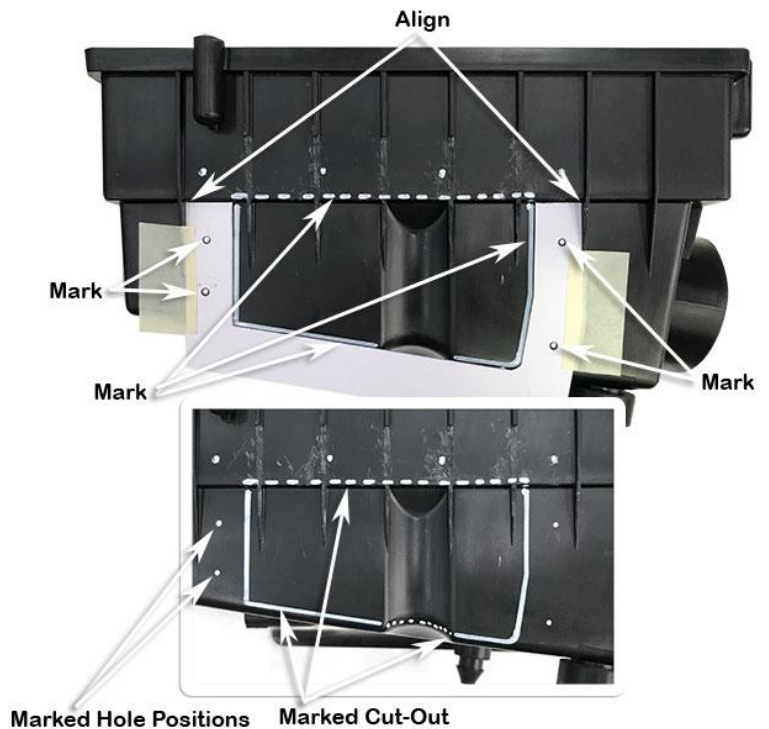

23

Align the lower air cleaner inlet template (item 27) onto the underside of the air cleaner base as shown.

Mark all four hole positions and cut-out section with a paint marker pen.

Remove the template.

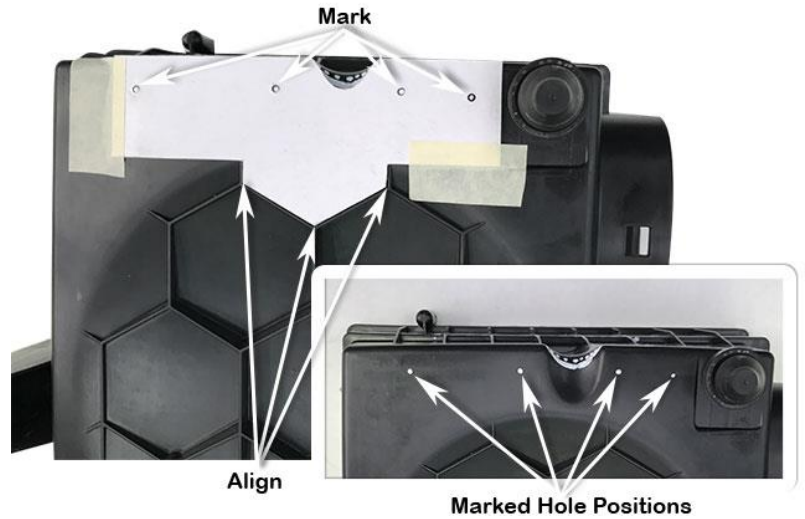

24

Using a 4.0mm drill bit, drill all 12 marked hole positions.

Using the body saw cut the new air inlet hole as marked from the templates in steps 22 & 23.

Use a file to clean-up the cut section, deburr all drilled holes.

A small section of an internal rib needs to be removed from the inside of the air cleaner base, using a sharp knife or grinder, remove the the rib as shown.

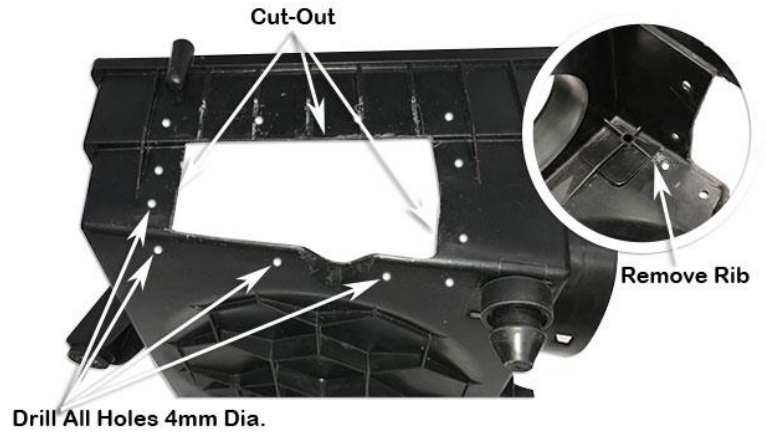

25

The four ribs around the air cleaner inlet snout must be completely removed, using a body saw, hacksaw blade or sharp knife remove the 4 ribs from around the air cleaner inlet snout as shown.

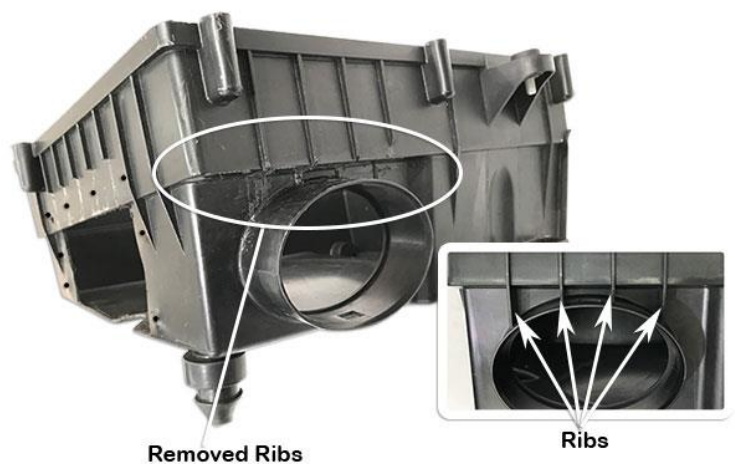

Apply adhesive sealant to the mating surfaces of the air entry hose.

Install the air entry hose onto the air cleaner base, install the upper, sides and lower clamping plates (item's 11, 12, 13 & 14) to the hose, install the air filter support plate (item 15), install all twelve pop rivets (note: the orientation of the four lower pop rivets), install a 4mm body washer (item 17) to the four lower pop rivets as shown.

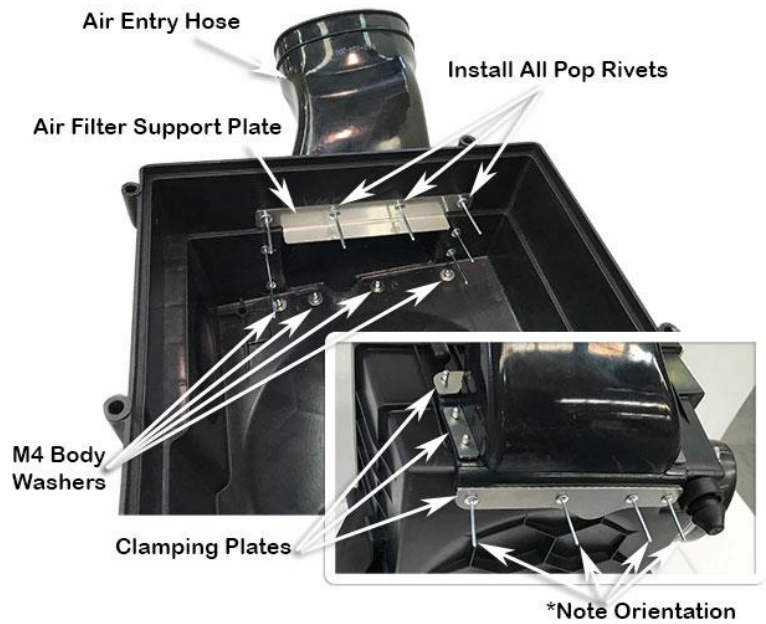

With all twelve pop rivets install, use the pop rivet gun to secure the pop rivets.

Clean-up any excess sealant to ensure a neat finish.

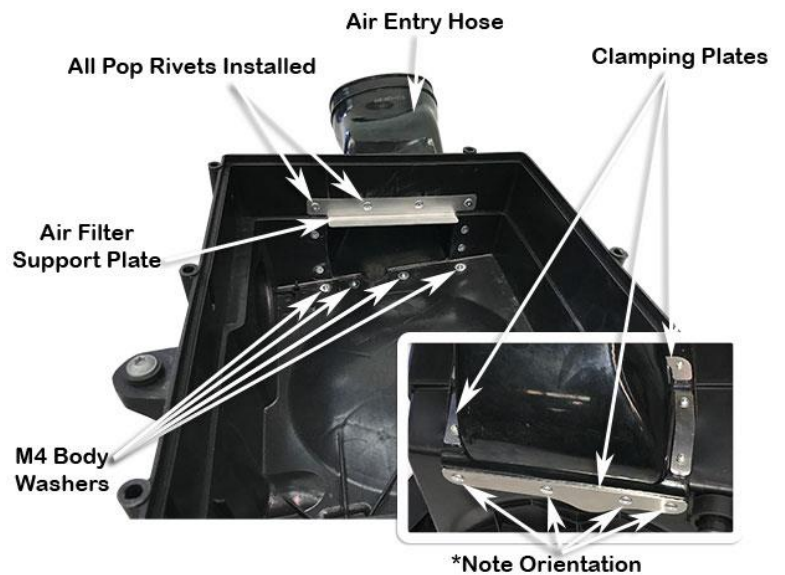

Install the air inlet blank-off cap (item 18) over the air cleaner inlet snout, with the blank-off cap correctly installed secure with a 70/90mm hose clamp (item 19), ensure the hose clamp is positioned to the rear edge of the blank-off cap.

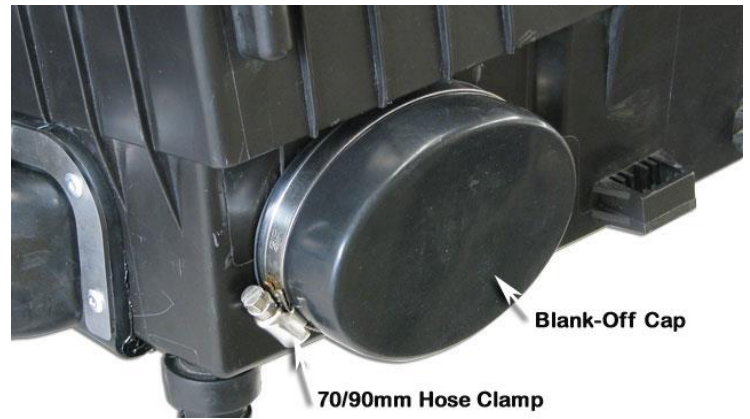

Install the coolant bypass hose into its mounts and position the wiring harness along the inner guard panel.

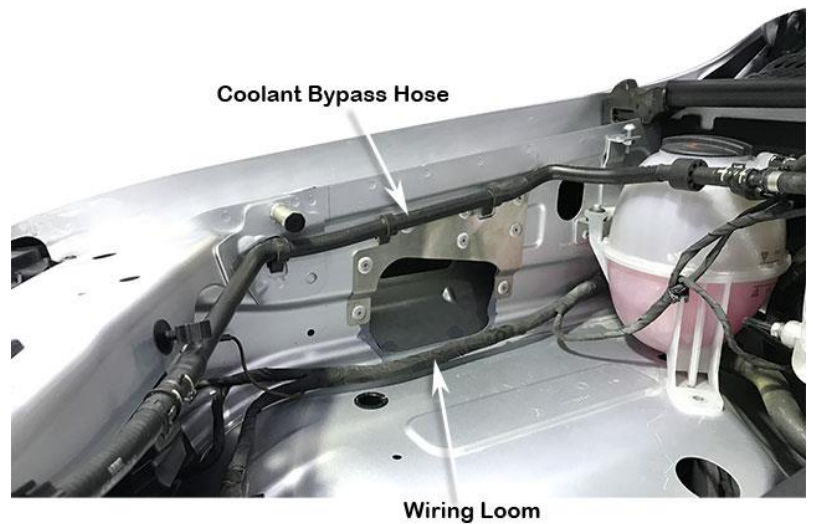

INSTALLER OPTION:

The air cleaner housing contains a drain valve as shown.

The serviceability of the drain valve must be checked by the installer.

If necessary the drain valve should be replaced or sealed with sealant by the installer, to prevent water from entering the air cleaner housing.



The end of the air entry hose (item 10) must be squashed inwards and taped to hold in position as shown.

N.B: it is critical the hose is taped the way shown in the photo, for installation purposes.



Tape Air Entry Hose

With the hose correctly taped, spray lubricant over the outside of the hose.

Install the air cleaner assembly into position, guiding the air entry hose through the holes in the inner guard panel, ensure the two air cleaner base mounting pins locate correctly into the mounting holes and fasten the rear mounting bolt.

Remove the tape.



Air Entry Hose

Shape the 90/110mm hose clamp (item 20) to the oval shape of the air entry hose, loosely install the hose clamp onto the air entry hose.

Carefully install the snorkel body (item 1) to the guard panel, guiding the snorkel body outlet snout into the air entry hose (item 10), align the snorkel body to the guard panel and upper mounting bracket.

When correctly aligned, fasten the snorkel body to the guard panel with body washers (item 8) and nyloc nuts (item 9).

Fasten the snorkel body to the upper mounting bracket with hex bolts (item 4).

Ensure the air entry hose is correctly installed onto the snorkel body outlet snout and tighten the 90/110mm hose clamp (item 20).



Install the washer bottle assembly, washer bottle filler neck, side indicator and connect wiring, install the air cleaner element and air cleaner lid and connect wiring and hoses. Top up the washer bottle with washer fluid and check washer operation, install the guard liner, mud flap and any other items that may have been removed during the snorkel installation process.

Install the black hose clamp (item 21) loosely to the base of the air ram assembly (item 2).

Install the air ram assembly onto the snorkel body.

Align the air ram and tighten the black hose clamp (item 21).



N.B: It is the installer's responsibility to ensure that all connections are water tight.